

BG Services  
BY ZENTEN

# Abteilung für Produkte in Kundeneigenaufmachung

Zukunftsorientiert denken —————>

ZENTEN

# BG Services

BY **ZENTEN**

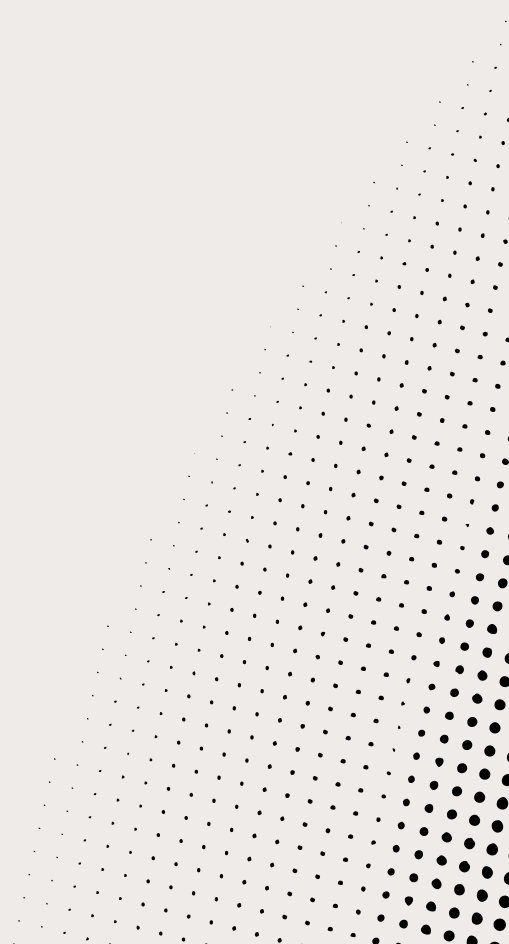

# Index

## ÜBER UNS



Zukunftsorientiert denken	04
-----	
BGServices	06
-----	
Zenten in Zahlen	10

## KATALOG



Rohrschneider für flexible Kunststoffschläuche	12
-----	
Rohrschneider für Kunststoffwellschutzrohre	16
-----	
Rohrschneider für flexible Schläuche, weiche Kunststoffrohre und dünnwandige Kunststoffrohre.	20
-----	
Rohrschneider für Verbundrohre	24
-----	
Rohrschneider für Kunststoff- und Verbundrohre.	28
-----	
Rohrschneider für dünnwandige Metallrohre.	40
-----	
Rohrschneider für Inox Rohre	54
-----	
Rohrschneider für Stahl- und Inox Rohre	62
-----	
Ersatzrädchen und Ersatzklingen	68
-----	
Installationswerkzeuge	74
-----	
Schlagschnurroller und Farbpulver für Schlagschnurroller	78
-----	
Messer	84







WIR SIND DAS HERVORRAGENDE  
HANDWERKZEUG.

Seit mehr als 50  
Jahren sind wir  
Spezialisten für die  
Herstellung von  
Werkzeugen  
höchster Qualität.

Produktive Flexibilität und Service  
auf höchstem Niveau sind unsere Lebenselixier.



EIN BISSCHEN GESCHICHTE

## Die Ursprünge von Zenten

Beständigkeit und Arbeit sind die Worte, die Zentens Geschichte begleiten. Die Geschichte begann 1966, als Bernhard Groten, ein junger Deutscher, beschloss, eine kleine Werkstatt in Irún zu eröffnen, in der Handbohrmaschinen und Schleifmaschinen hergestellt wurden.

Diese kleine Werkstatt ist heute eine Fabrik von fast 5.000 m<sup>2</sup>, in der 50 Spezialisten für die Herstellung von Handwerkzeugen arbeiten. Eine moderne Fabrik mit Einrichtungen, mit denen wir weiter wachsen können. Maschinen der neuesten Generation und speziell von uns entwickelt.

WIR MACHEN ES SO

## Unsere Erfahrung

Wir kreieren, entwickeln und stellen her für diejenigen, die Hervorragendes schätzen, die wahre Herkunft der von ihnen gehandhabten Produkte kennen und mit Qualität arbeiten möchten.

Die hohe Qualität, das innovative Design und die perfekte Verarbeitung unserer Werkzeuge machen uns in den wichtigsten Märkten präsent. Perfektion ist das Ergebnis harter Arbeit, Leidenschaft und Aufmerksamkeit.

Jedes Jahr liefern wir über 1.000.000 Artikel, von denen wir 95% exportieren. Wir sind Experten für die Zusammenarbeit mit internationalen Kunden.

VON PARTNER ZU PARTNER

## Wohin gehen Wir

Das grösste Vermächtnis, das man hinterlässt, ist nicht der Reichtum, sondern die Vermittlung des Weges, der zu gehen ist. Unser Weg ist es Hervorragendes weiterzugeben von Partner zu Partner und von Generation zu Generation.

Neue Prozesse, technologische Fortschritte, Managementinnovationen ... sind Teil der ZENTEN-Philosophie. Und deshalb verbessern sich unsere Werkzeuge immer weiter.

Es ist Zeit der Veränderungen. Es ist Zeit der guten Profis. Und so werden wir weitermachen.



Zukunftsorientiert denken →

# Abteilung für Produkte in Kundeneigenaufmachung

Klar kundenorientiert wird zeitnah  
eine effektive und effiziente Arbeit garantiert  
mit optimalem Produktergebniss.





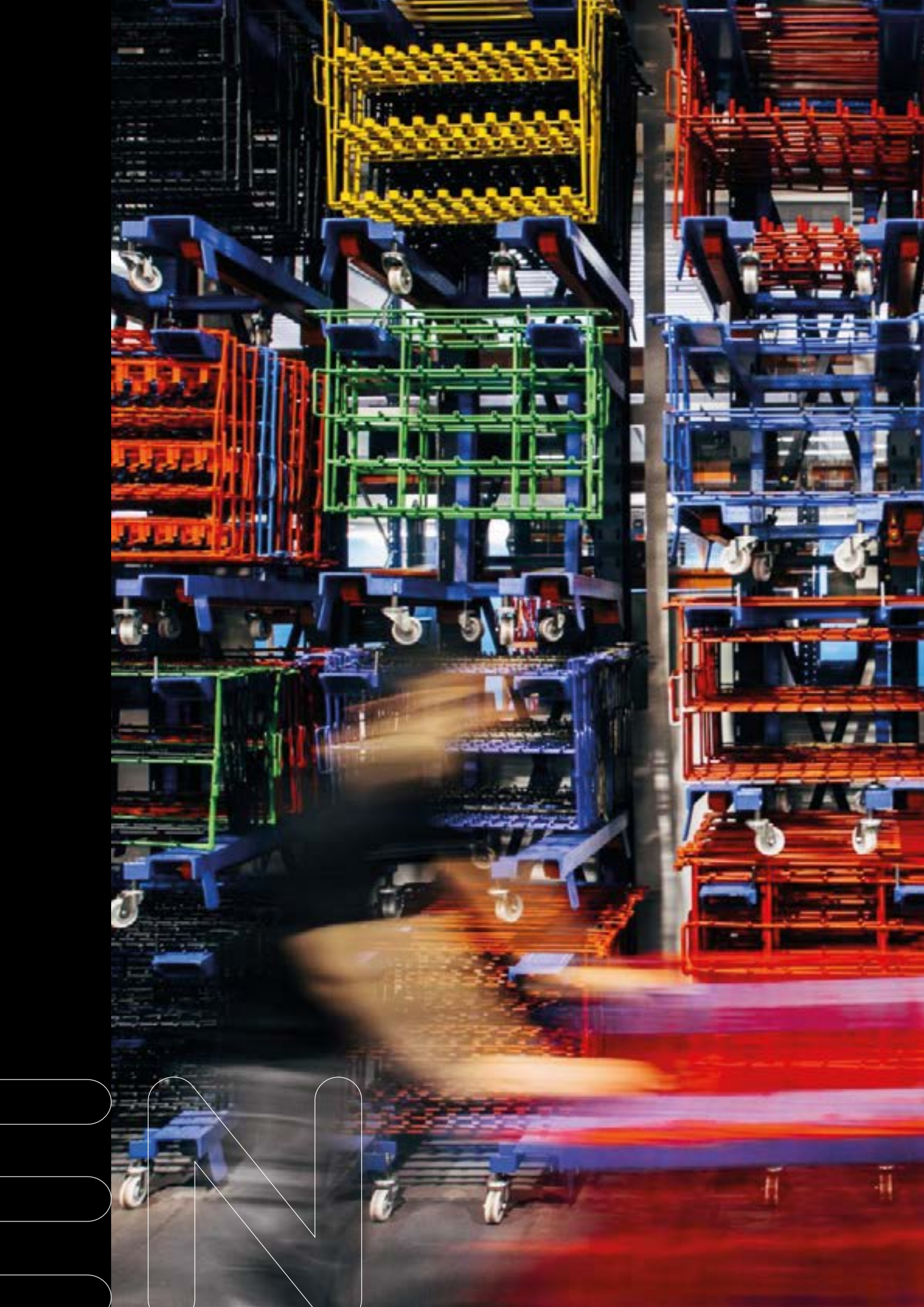

1

2

3

4

5

6

7

8

9

10

11

12

13

14

15

16

17

18

19

20

21

22

23

24

25

26

27

28

29

30

31

32

33

34

35

36

37

38

39

40

41

42

43

44

45

46

47

48

49

50

51

52

53

54

55

56

57

58

59

60

61

62

63

64

65

66

67

68

69

70

71

72

73

74

75

76

77

78

79

80

81

82

83

84

85

86

87

88

89

90

91

92

93

94

95

96

97

98

99

100



# Anpassung Optionen

Designflexibilität und Anpassung, Spezial-Fertigung und außergewöhnlicher Service bieten ein differenziertes, einzigartiges Produkt, das sich von den bestehenden unterscheidet. Wir geben Ihnen die Möglichkeit, Ihr eigenes Produkt zu haben.





## Logo Markierung

Beziehen Sie die Produkte aus unserem Katalog mit Ihrem eigenen Logo. Eine wesentliche Möglichkeit für den Benutzer, seine Marke zu haben.



GUSSMARKIERUNG



LASERMARKIERUNG



ETIKETT



## Produktfarbe

Wir haben eine große Auswahl an Farben, damit Ihr Werkzeug eine einzigartige Persönlichkeit erhält und auf Ihre Markenidentität abgestimmt ist.



STANDARD FARBEN

\* Andere Farben auf Anfrage



## Identität und Verpackung

Wir bieten Ihnen die Möglichkeit, das Produkt nach Ihren Wünschen mit einer attraktiven Verpackung zu versehen, die der Markenidentität Ihres Unternehmens entspricht.



LOSE



PRODUKT  
AUF AB-KARTE



PRODUKT  
IN BLISTER



ONLINE PRODUKT KATALOG

## Katalog anpassbarer Produkte

Entdecken Sie mit unserem Produktanpassungsprogramm, wie Ihr Produkt aussehen könnte. Jedes Produkt hat sein eigenes Programm auf seiner entsprechenden Seite auf unserer Website.



Zukunftsorientiert denken →



+1.000.000

Werkzeuge pro Jahr

00

EINIGE DATEN

## ZENTEN in Zahlen

95%

unserer Produktion  
wird exportiert.

VON IRUN IN DIE WELT

90%

unserer Lieferanten sind weniger  
als 100 km entfernt von uns.

LOKALE PRODUKTION

# +50

Spezialisten in  
der Herstellung  
von Handwerkzeugen

## Team

Wir sind ein Team von Spezialisten in der Herstellung von Handwerkzeugen.  
Vom Konzept bis zur Herstellung.

---

## Service

Wir unterstützen unsere Kunden vor und nach dem  
Kauf mit einem effizienten und agilen Service.

---

## Produkt

Wir testen unsere Werkzeuge in der Praxis, um funktionale,  
moderne und attraktive Produkte für den Anwender zu entwickeln.

# 5.000 m<sup>2</sup>

von modernen und  
funktionalen Einrichtungen.

**UNSERE FABRIK**

Zukunftsorientiert denken —————→

ROHRABSCHNEIDER

---

# Für flexible Kunststoffschläuche.

Zukunftsorientiert denken —————>

ZENTEN

01.



EN

# denakut

Ø 5/8"  
16 mm



ZENTEN

## MERKMALE



### Effizient

Minimale Anwendungskraft für den Schnitt.



### Praktisch

Automatischer Klinsenrückzug.



### Qualität

Klinge „Made in Solingen / Germany“. Optimale Schneidgeometrie und mit PTFE-Beschichtung.



### Handlich

Einhandverschlussystem.

Ref.	Ext.Ø mm	gr.	Verpackung		
5014-0	16	80	Lose	28	112
5014-1	16	90	SB	6	60

## ERSATZTEIL



5009-1

# denakut

Ø 7" / 8"  
22 mm

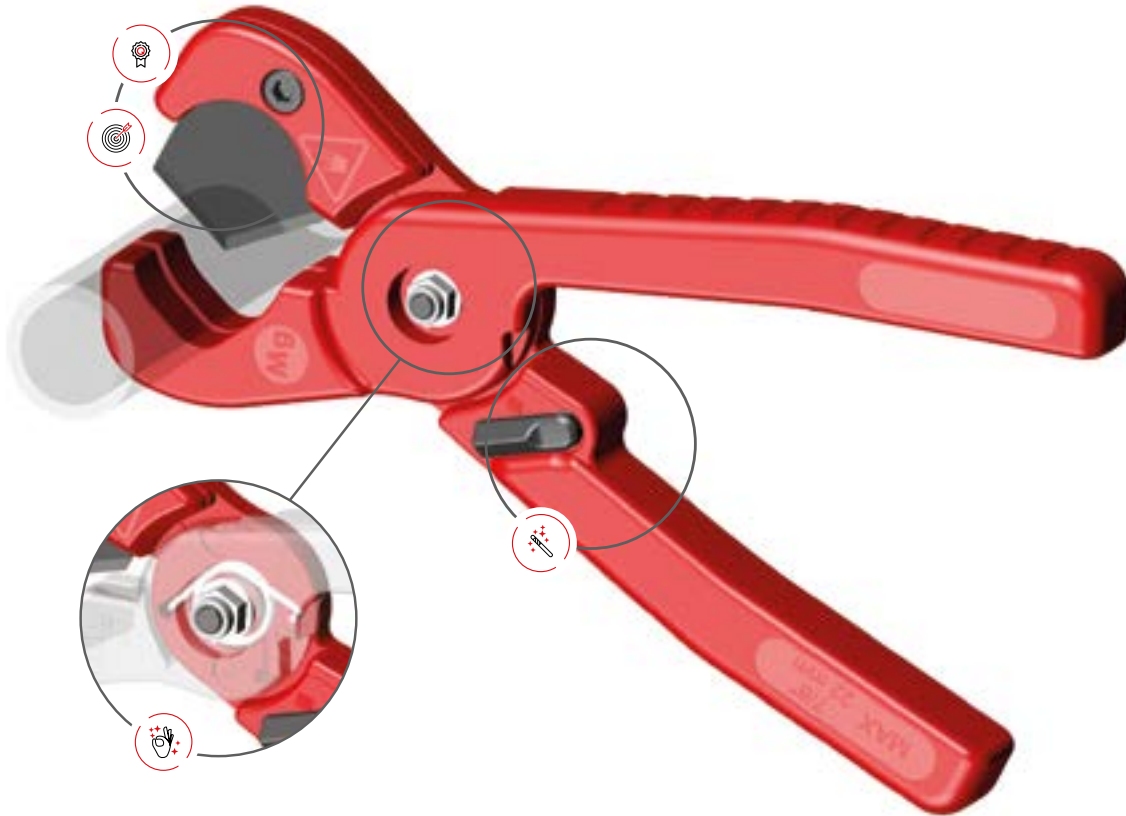

## MERKMALE



### Effizient

Minimale Anwendungskraft für den Schnitt.



### Praktisch

Automatischer Klinsenrückzug.





### Qualität

Klinge „Made in Solingen / Germany“. Optimale Schneidgeometrie und mit PTFE-Beschichtung.



### Handlich

Einhandverschlussystem.

Ref.	Ext. Ø mm		Verpackung		
5022-0	22	150	Lose	6	60
5022-1	22	160	SB	5	50

## ERSATZTEIL



+ PTFE

5011-1



ROHRABSCHNEIDER

---

# Für Kunststoffwellschutzrohre.

Zukunftsorientiert denken —————>

ZENTEN

02.

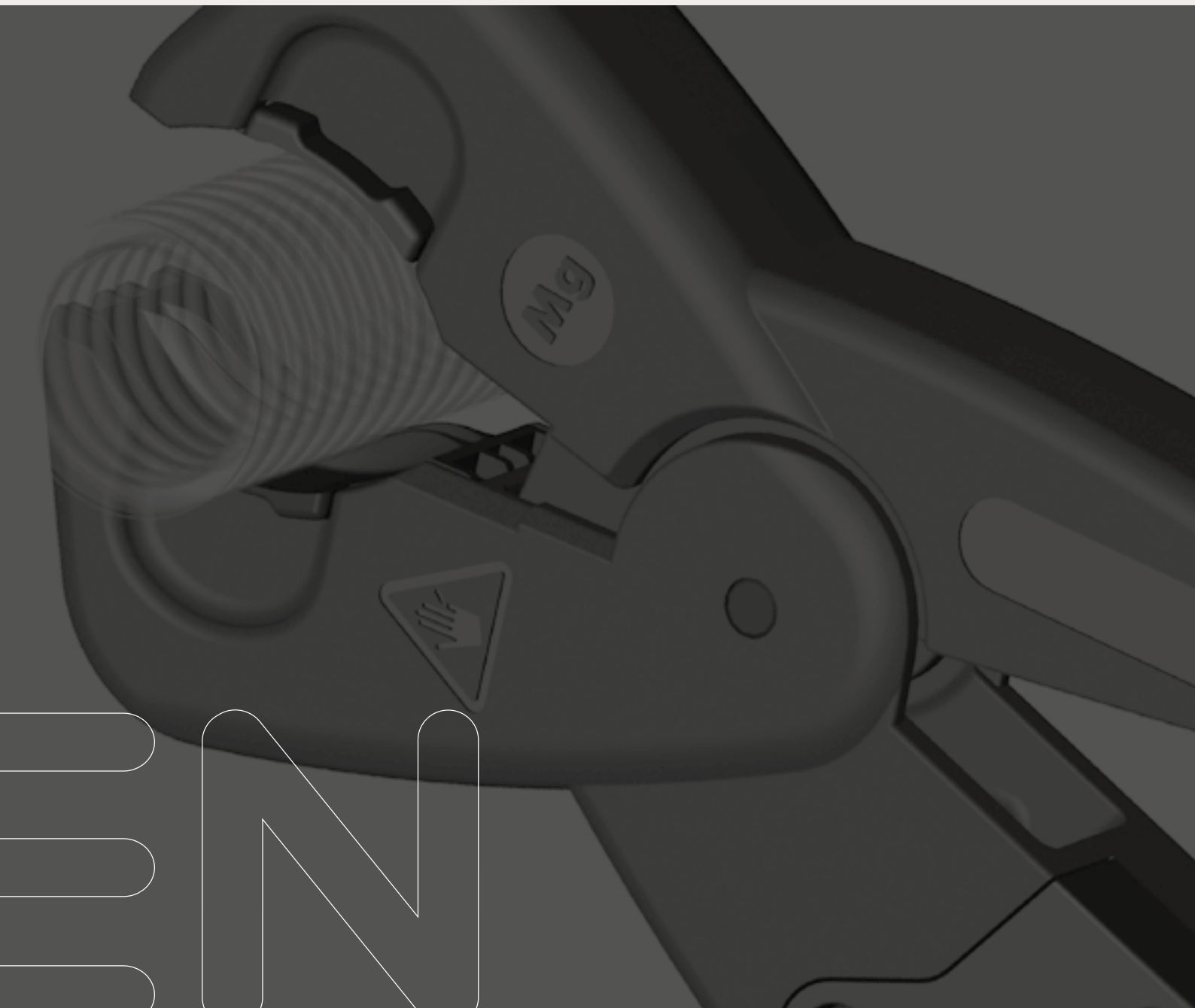

EN

# denakut

Ø 9/16" -1.3/4"  
14-45 mm



ZENTEN Brandmark

## MERKMALE



### Lösung. Zwei Schneidsysteme:

Querschnitt: Mit 2 vierschneidigen Klingen. Viermal längere Lebensdauer des Systems durch die 4-fache Verstellbarkeit der Klinge um 90°. Rohrführungssystem für perfekte Positionierung des Rohres beim Schneiden. Klingen liegen geschützt im Körper, was Beschädigungen der Schneiden und Verletzungen des Anwenders vermeidet

Längsschnitt: Mit 1 vierschneidigen Klinge. Viermal längere Lebensdauer des Systems durch die 4-fache Verstellbarkeit der Klinge um 90°. Klinge liegt geschützt im Körper, was Beschädigungen der Schneide und Verletzungen des Anwenders vermeidet. Rohraufgabe zur besseren Führung des Rohres.



Ref.	Ext.Ø mm	 gr	Verpackung		
5045-0	14-45	150	Lose	8	80
5045-1	14-45	160	SB	5	60

## ERSATZTEIL



**5013-1**  
3 ST.

**BG Services**  
BY **ZENTEN**

ROHRABSCHNEIDER

---

Für flexible Schläuche,  
weiche Kunststoffrohre  
und dünnwandige  
Kunststoffrohre.

Zukunftsorientiert denken —————→

ZENTEN

03.



EN



# denakut

Ø 1.1/8"  
28 mm



ZENTEN Brandmark  
© 2017

22

## MERKMALE



### Effizient

Minimale Anwendungskraft für den Schnitt.



### Praktisch

Automatischer Klinsenrückzug.



### Resistent

Rotations-System mit stahlgelagerter Achse mit Nadellager.



### Handlich

Einhandverschlussystem.





### Qualität

Klinge „Made in Solingen / Germany“. Optimale Schneidgeometrie und mit PTFE-Beschichtung.



### Komfort

Zweikomponentengriff mit Anti-Impact Dämpfung.

Ref.	Ext.Ø mm	gr.	Verpackung		
5028-0	28	215	Lose	6	60
5028-1	28	230	SB	5	50

## ERSATZTEIL



# denakut

Ø 1.1/8"  
28 mm

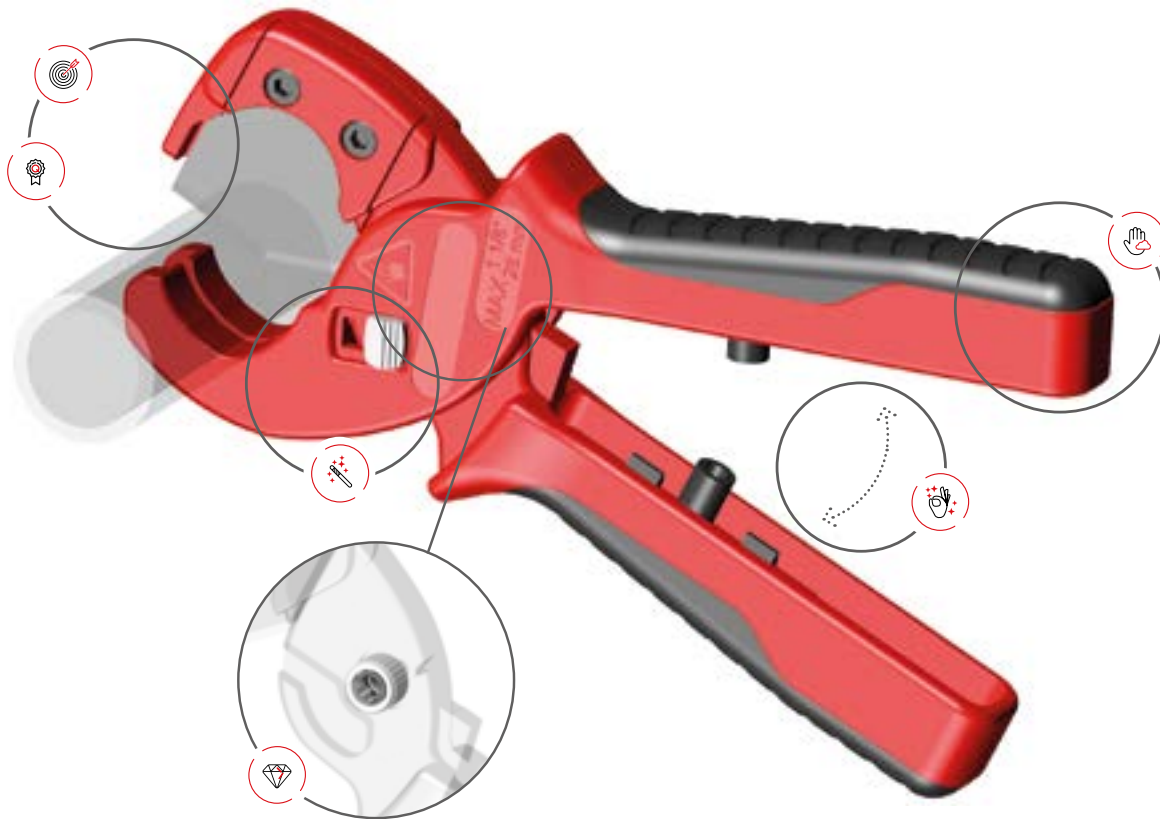

## MERKMALE



### Effizient

Minimale Anwendungskraft für den Schnitt.



### Praktisch

Automatischer Klinsenrückzug.



### Resistent

Rotations-System mit stahlgelagerter Achse mit Nadellager.



### Handlich

Einhandverschlussystem.





### Qualität

Optimale Schneidgeometrie.



### Komfort

Zweikomponentengriff mit Anti-Impact Dämpfung.

Ref.	Ext. Ø mm	gr	Verpackung		
5028-2	28	215	Lose	6	60
5028-3	28	230	SB	5	50

## ERSATZTEIL



5007-3

ROHRABSCHNEIDER

---

# Für Verbundrohre.

Zukunftsorientiert denken —————>



ZENTEN

04.



EN

# denakut

Ø 1"  
26 mm

**Mg**  
magnesium

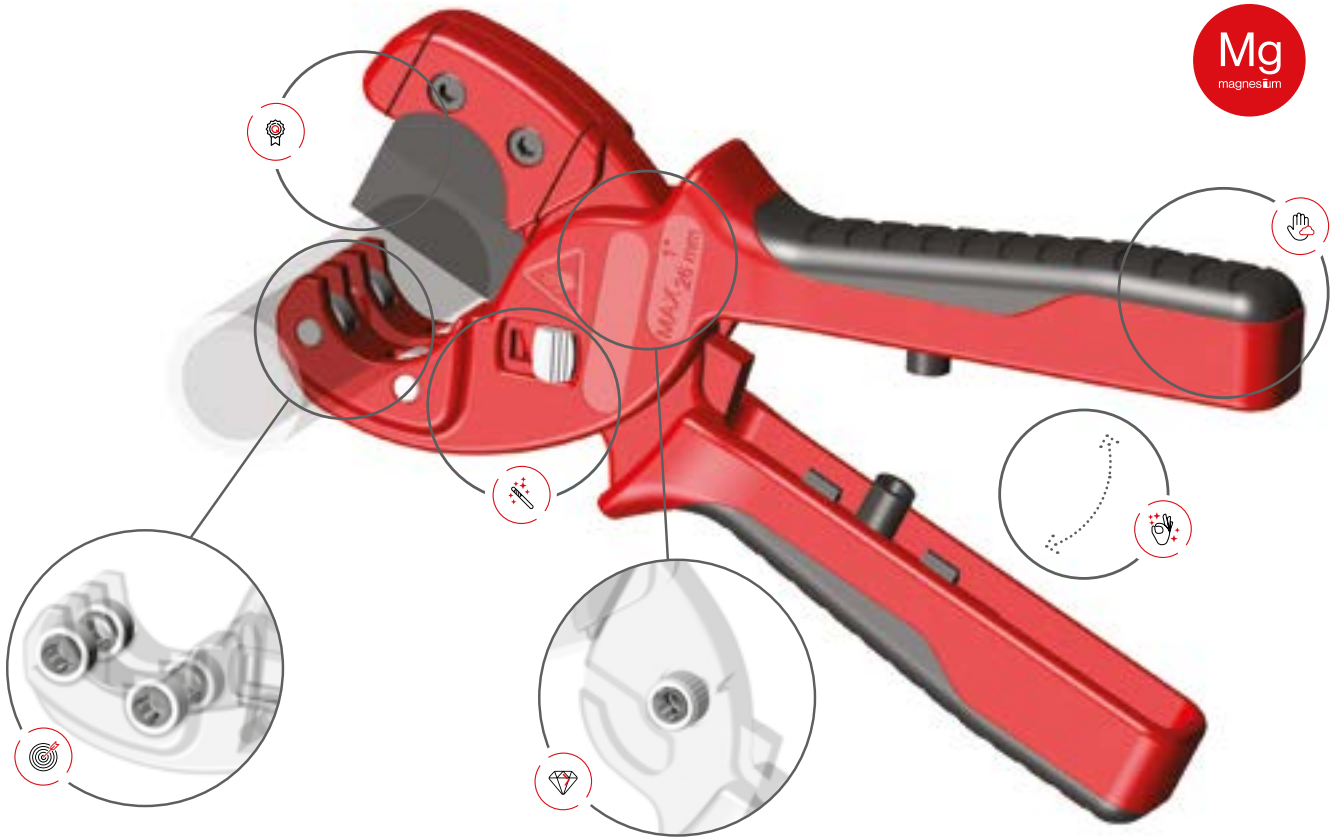

ZENTEN  
26

## MERKMALE



### Effizient

Twist&Cut™-System. 4 nadelgelagerte Führungsrollen vereinfachen das Drehen des Rohres beim Schneiden.



### Resistent

Rotations-System mit stahlgelagerter Achse mit Nadellager.



### Qualität

Klinge „Made in Solingen / Germany“. Optimale Schneidgeometrie und mit PTFE-Beschichtung.



### Praktisch

Automatischer Klinsenrückzug.





### Handlich

Einhandverschlussystem.



### Komfort

Zweikomponentengriff mit Anti-Impact Dämpfung.

Ref.	Ext. Ø mm		Verpackung		
5226-0	26	235	Lose	5	50
5226-1	26	250	SB	5	50

## ERSATZTEIL



+ PTFE

**5006-1**

# denakut +

Ø 1"  
26 mm

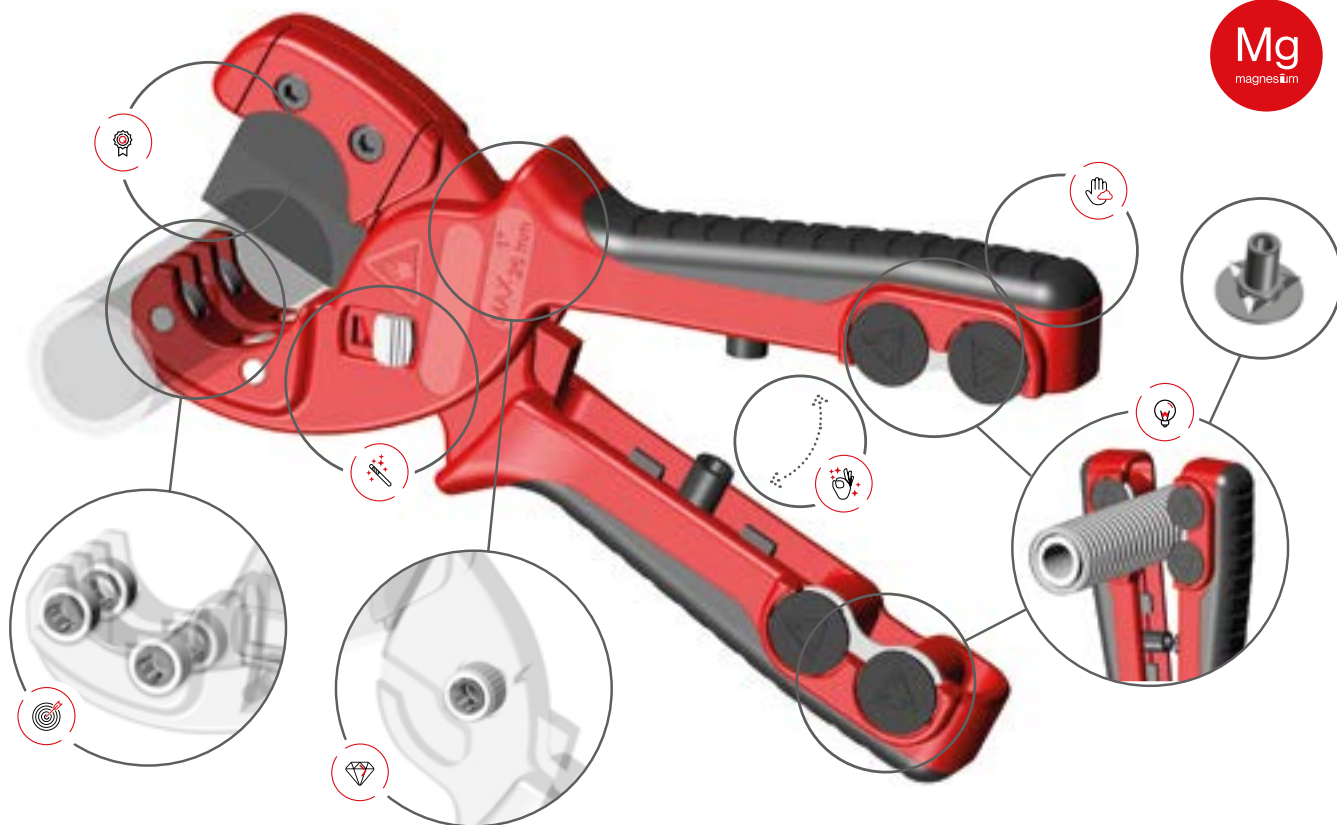

ZENTEN 27

## MERKMALE



### Effizient

Twist&Cut®-System. 4 nadelgelagerte Führungsrollen vereinfachen das Drehen des Rohres beim Schneiden.



### Praktisch

Automatischer Klingentrückzug.



### Lösung

Integrierter Schutzwellrohrscheider. Schneiden des Schutzwellrohres (18-35mm) ohne das innere Rohr zu beschädigen. Mit 4 dreischneidigen Klingen. Dreimal längere Lebensdauer des Systems mit einer 120° Umdrehung der Klinge. Mit PTFE Beschichtung.



### Resistent

Rotations-System mit stahlgelagerter Achse mit Nadellager.



### Handlich

Einhandverschlussssystem.





### Qualität

Klinge „Made in Solingen / Germany“. Optimale Schneidgeometrie und mit PTFE-Beschichtung.



### Komfort

Zweikomponentengriff mit Anti-Impact Dämpfung.

Ref.	Ext. Ø mm	 gr	Verpackung		
5126-0	26	270	Lose	5	50
5126-1	26	285	SB	5	50

## ERSATZTEIL

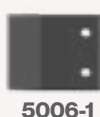

+ PTFE



**5008-1**  
4 ST.

+ PTFE



ROHRABSCHNEIDER

---

# Für Kunststoff- und Verbundrohre.

Zukunftsorientiert denken 



ZENTEN

05.



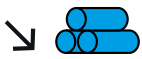

Für Kunststoff- und Verbundrohre.

MODELL 5026

# raptor

Ø 1"  
26 mm



ZENTEN  
Brennspiegel  
Druck

30

## MERKMALE



### Effizient

Leichter, schneller und präziser Schnitt. Minimale Anwendungskraft für den Schnitt.



### Praktisch

Automatischer Klinsenrückzug.



### Sofortiger

ICS-System (Instant Change System). Klinsen-Schnellwechsel ohne Werkzeug.



### Qualität

INOX-Klinge „Made in Solingen / Germany“. Optimale Schneidgeometrie und PTFE-Beschichtung.



Ref.	Ext.Ø mm	gr.	Verpackung		
5026-0	26	235	Lose	5	50
5026-1	26	250	SB	4	40

## ERSATZTEIL



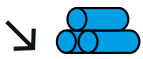

Für Kunststoff- und Verbundrohre.

MODELL 5035

# raptor

Ø 1.3/8"  
35 mm



## MERKMALE



### Effizient

Leichter, schneller und präziser Schnitt. Minimale Anwendungskraft für den Schnitt.



### Qualität

INOX-Klinge „Made in Solingen / Germany“. Optimale Schneidengeometrie und PTFE-Beschichtung.



### Sofortiger

ICS-System (Instant Change System). Klingen-Schnellwechsel ohne Werkzeug.



### Praktisch

Automatischer Klingenrückzug.



### Sicherheit

Klinge geschützt im Körper. Vermeidet Beschädigungen der Schneide und Verletzungen des Anwenders.

Ref.	Ext.Ø mm	gr	Verpackung		
5035-0	35	270	Lose	5	50
5035-1	35	285	SB	4	40

## ERSATZTEIL



# raptor

Ø 1.5/8"  
42 mm



ZENTEN  
Brandspiegel  
Druck

32

## MERKMALE



### Effizient

Leichter, schneller und präziser Schnitt. Minimale Anwendungskraft durch progressiven zahngeführten Klingenvorschub.



### Praktisch

Einhand-Schnellrückzug der Klinge.



### Sofortiger

ICS-System (Instant Change System).  
Klingen-Schnellwechsel ohne Werkzeug.



### Qualität

INOX-Klinge „Made in Solingen / Germany“.  
Optimale Schneidgeometrie und PTFE-Beschichtung.



### Sicherheit

Klinge geschützt im Körper. Vermeidet Beschädigungen der Schneide und Verletzungen des Anwenders.



### Komfort

Zweikomponentengriff. Liegt sicher und bequem in der Hand.



Ref.	Ext.Ø mm	gr	Verpackung		
5042-0	42	430	Lose	3	30
5042-1	42	455	SB	6	18

## ERSATZTEIL



+ PTFE

5002-1

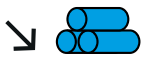

Für Kunststoff- und Verbundrohre.

MODELL 5050

# raptor

Ø 2"  
50 mm

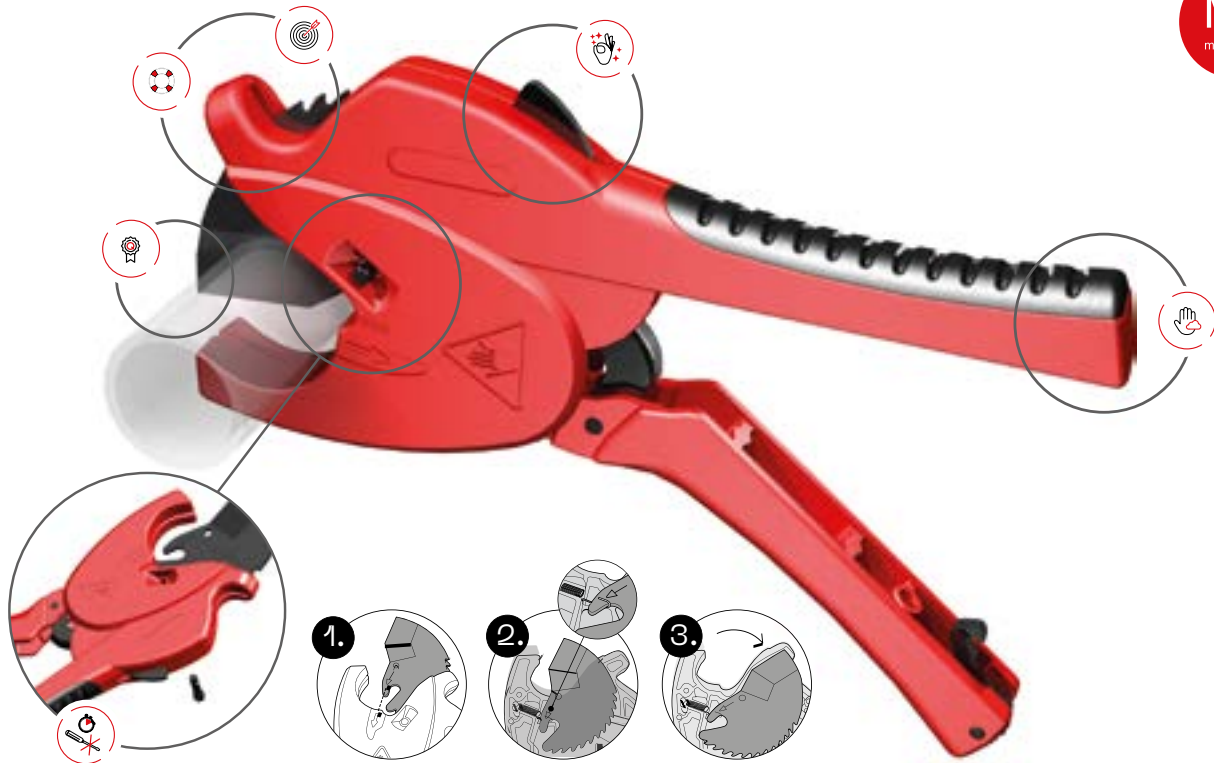

ZENTEN

33

## MERKMALE



### Effizient

Leichter, schneller und präziser Schnitt. Minimale Anwendungskraft durch progressiven zahngeführten Klingenvorschub.



### Praktisch

Einhand-Schnellrückzug der Klinge.



### Sofortiger

ICS-System (Instant Change System).  
Klingen-Schnellwechsel ohne Werkzeug.



### Qualität

NOX-Klinge „Made in Solingen / Germany“. Optimale Schneidgeometrie und PTFE-Beschichtung.



### Sicherheit

Klinge geschützt im Körper. Vermeidet Beschädigungen der Schneide und Verletzungen des Anwenders.



### Komfort

Zweikomponentengriff. Liegt sicher und bequem in der Hand.

Ref.	Ext. Ø mm	gr.	Verpackung		
5050-0	50	455	Lose	3	30
5050-1	50	480	SB	6	18

## ERSATZTEIL



+ PTFE

5003-1





# raptor

Ø 2 1/2"  
63 mm

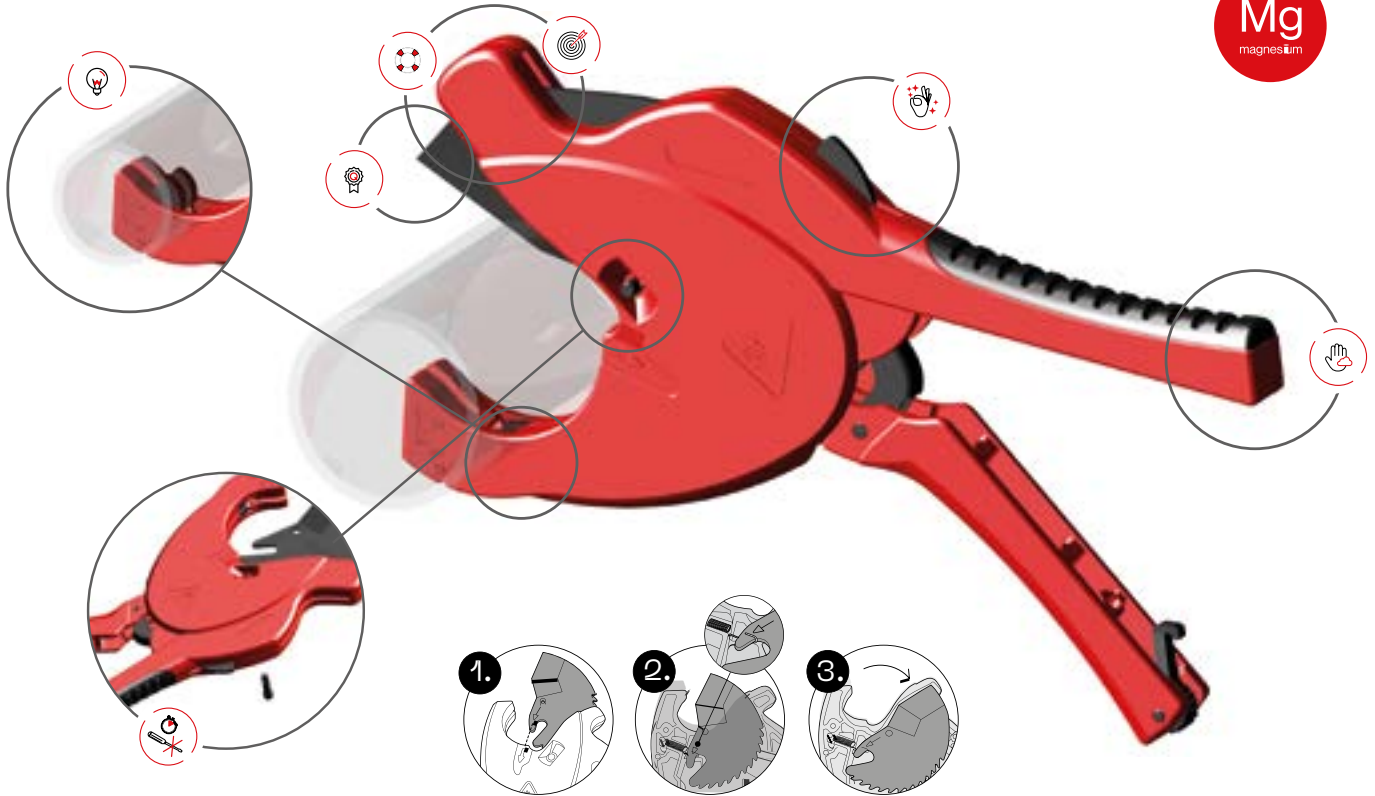

ZENTEN Brandmarken

34

## MERKMALE



### Effizient

Leichter, schneller und präziser Schnitt. Minimale Anwendungskraft durch progressives zahngeführtes Klingenvorschub.



### Sicherheit

Klinge geschützt im Körper. Vermeidet Beschädigungen der Schneide und Verletzungen des Anwenders.



### Praktisch

Einhand-Schnellrückzug der Klinge.



### Lösung

Verstellbares Rohrannäherungssystem für Rohre bis 50mm. Besserer Schnitt.



### Qualität

INOX-Klinge „Made in Solingen / Germany“. Optimale Schneidgeometrie und PTFE-Beschichtung.





### Sofortiger

ICS-System (Instant Change System). Klingen-Schnellwechsel ohne Werkzeug.



### Komfort

Zweikomponentengriff mit Anti-Impact Dämpfung.

Ref.	Ext.Ø mm		Verpackung		
5063-0	63	610	Lose	6	18
5063-1	63	645	SB	5	15

## ERSATZTEIL



+ PTFE

5004-1

# kompakt + ptquick

Ø1/4"-2 1/6"  
6-54 mm

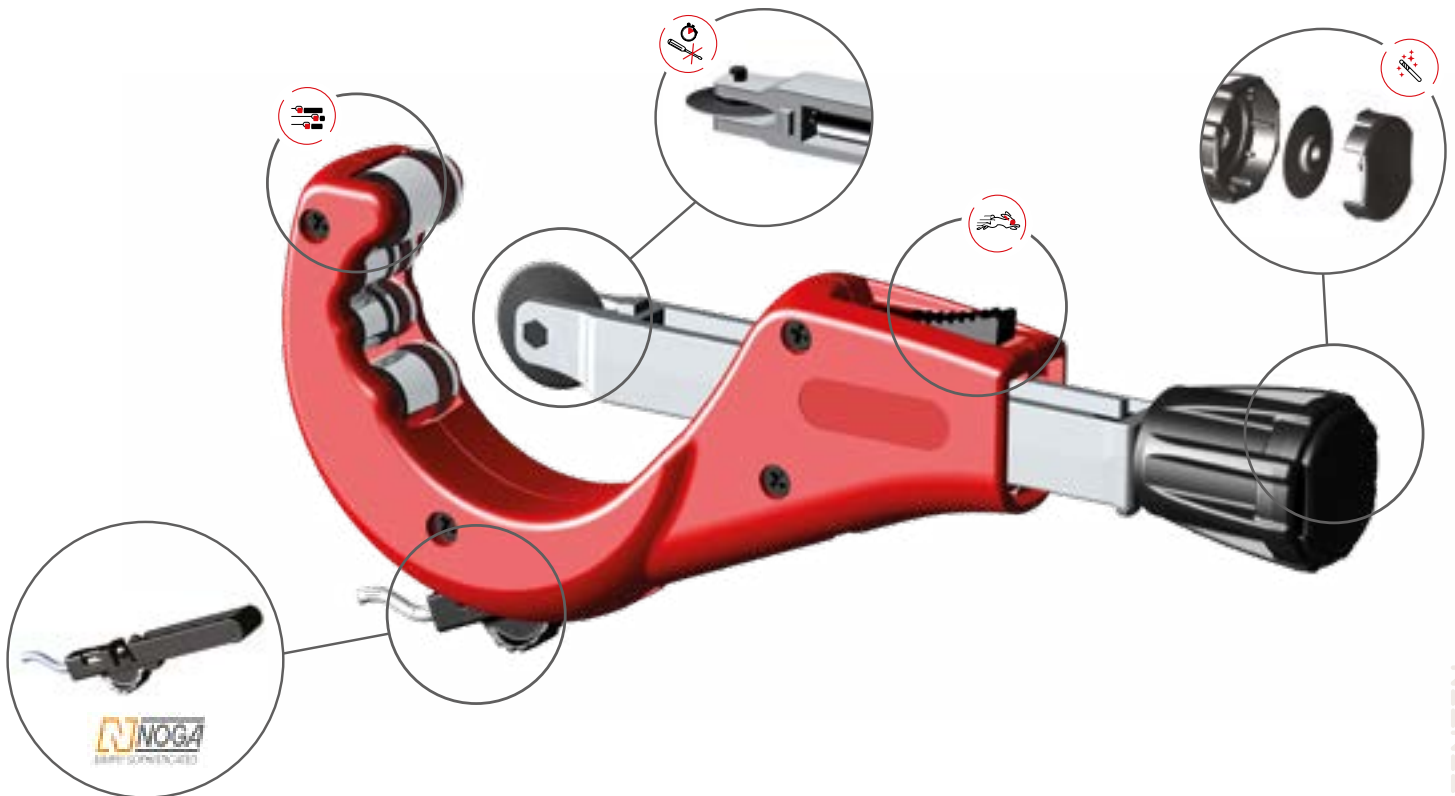

## MERKMALE



### Schnell

Schnell-Vorschub System.



### Praktisch

NOGA Entgrater-Klinge. Kann komplett herausgezogen werden.



### Sofortiger

ICS-System (Instant Change System).  
Klingen-Schnellwechsel ohne Werkzeug.







### Handlich

Ersatzrädchen in Drehknauf-Kappe.



### Stabil

4 Führungsrollen für einen optimalen  
Halt des Rohres.

Ref.	Ext. Ø mm			Verpackung		
7454-8	6-54	2x	725	Lose	1	15
7454-9	6-54	2x	745	SB	-	12

## ERSATZTEIL



**6017-0**  
30x6,20mm





# kompakt + ptquick

Ø 1/4" - 3"  
6-76 mm



## MERKMALE



**Schnell**  
Schnell-Vorschub System.



**Praktisch**  
NOGA Entgrater-Klinge. Kann komplett herausgezogen werden.



**Sofortiger**  
ICS-System (Instant Change System).  
Klingen-Schnellwechsel ohne Werkzeug.



**Handlich**  
Ersatzrädchen in Drehknopf-Kappe.



**Stabil**  
4 Führungsrollen für einen optimalen Halt des Rohres.

Ref.	Ext.Ø mm		gr.	Verpackung		
7476-8	6-76	2x	880	Lose	1	15
7476-9	6-76	2x	905	SB	-	12

## ERSATZTEIL



**6017-0**  
30x6,20mm

**BG Services**  
BY **ZENTEN**

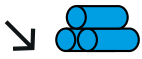

Für Kunststoff- und Verbundrohre.

MODELL 7477

# kompakt + ptquick

Ø 2" - 5"  
50-127 mm

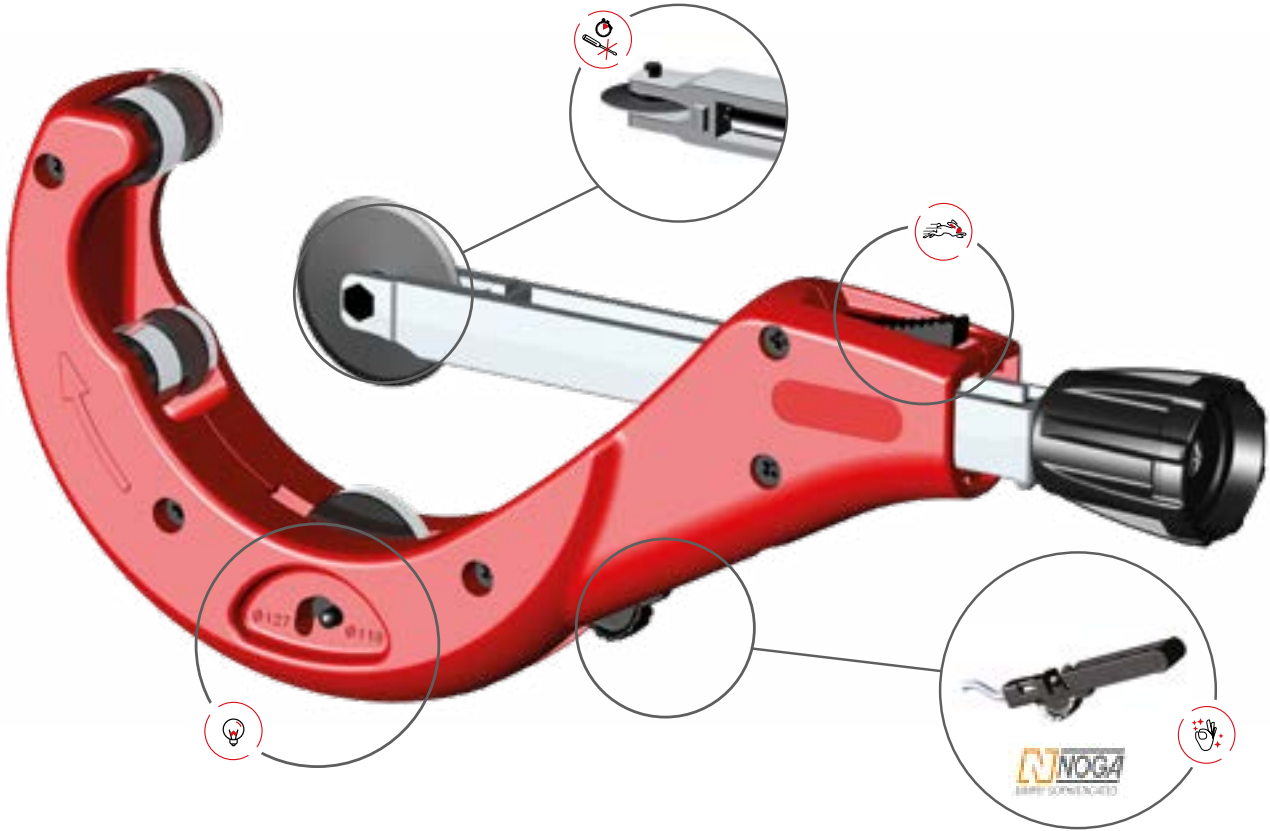

ZENTEN

38

## MERKMALE



### Lösung

In zwei Positionen (110mm und 127mm) verstellbare dritte Führungsrolle für eine optimale Führung des Rohres beim Schneiden.  
- Position 110mm: Zum Schneiden von Rohren bis inklusive 110mm.  
- Position 127mm: Zum Schneiden von Rohren ab 110mm und bis 127mm.



### Sofortiger

ICS-System (Sofortiger Change System).  
No tool required for Sofortiger blade change.



### Schnell

Schnell-Vorschub System.



### Praktisch

NOGA Entgrater-Klinge. Kann komplett herausgezogen werden.

Ref.	Ext. Ø mm		mm	gr.		
7477-2	50-127	1x	11,8	1620	1	6
7477-3	50-127	1x	11,8	1620	1	6
7477-4	50-127	1x	16,8	1625	1	6
7477-5	50-127	1x	16,8	1625	1	6
7477-6	50-127	1x	19,8	1630	1	6
7477-7	50-127	1x	19,8	1630	1	6

## ERSATZTEIL

	+ PTFE
<b>7403-0</b>	35x11mm
	+ PTFE
<b>7404-0</b>	45x11mm
	+ PTFE
<b>7405-0</b>	51x11mm

Ref.	Ext. Ø mm		mm	gr.		
7477-8	50-127	1x	27,8	1655	1	6
7477-9	50-127	1x	27,8	1655	1	6
7487-4	50-127	1x	16,8	1625	1	6
7487-5	50-127	1x	16,8	1625	1	6
7487-6	50-127	1x	19,8	1630	1	6
7487-7	50-127	1x	19,8	1630	1	6

## ERSATZTEIL

	+ PTFE
<b>7406-0</b>	67x11mm
<b>7407-0</b>	45x11mm
<b>7409-0</b>	51x11mm

\*Verpackungsoptionen: gerade Referenzen, weiße Schachtel / ungerade Referenzen, bedruckte Schachtel

# kompakt + ptquick

Ø 4"-6.5/8"  
100-170mm

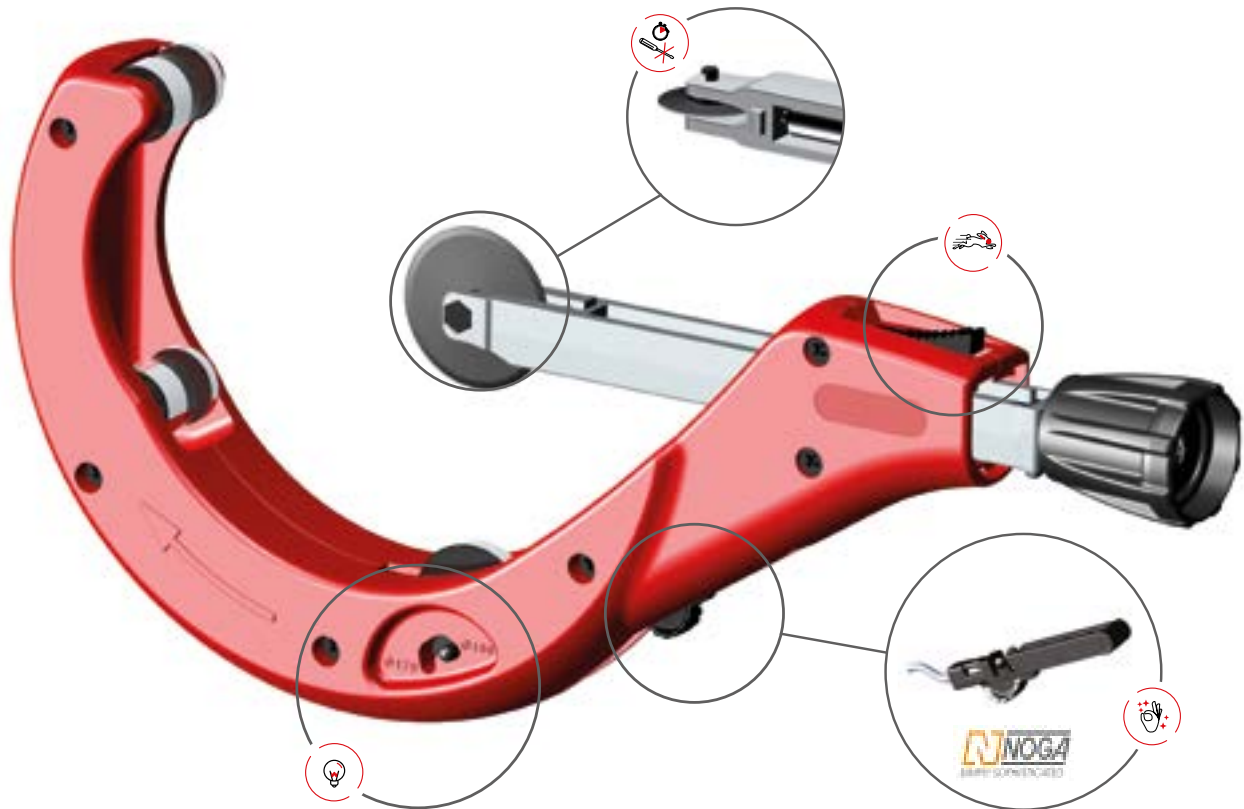

## MERKMALE



### Lösung

In zwei Positionen (160mm und 170mm) verstellbare dritte Führungsrolle für eine optimale Führung des Rohres beim Schneiden.  
- Position 160mm: Zum Schneiden von Rohren bis inklusive 160mm.  
- Position 170mm: Zum Schneiden von Rohren ab 160mm und bis 170mm.



### Sofortiger

ICS-System (Instant Change System).  
Klingen-Schnellwechsel ohne Werkzeug.



### Schnell

Schnell-Vorschub System.



### Praktisch

NOGA Entgrater-Klinge. Kann komplett herausgezogen werden.

Ref.	Ext. Ø mm		Ø mm	gr		
7478-2	100-170	1x	11,8	1830	1	6
7478-3	100-170	1x	11,8	1830	1	6
7478-4	100-170	1x	16,8	1835	1	6
7478-5	100-170	1x	16,8	1835	1	6
7478-6	100-170	1x	19,8	1840	1	6
7478-7	100-170	1x	19,8	1840	1	6

### ERSATZTEIL

+ PTFE	<b>7403-0</b> 35x11mm
+ PTFE	<b>7404-0</b> 45x11mm
+ PTFE	<b>7405-0</b> 51x11mm

Ref.	Ext. Ø mm		Ø mm	gr		
7478-8	100-170	1x	27,8	1865	1	6
7478-9	100-170	1x	27,8	1865	1	6
7488-4	100-170	1x	16,8	1835	1	6
7488-5	100-170	1x	16,8	1835	1	6
7488-6	100-170	1x	19,8	1840	1	6
7488-7	100-170	1x	19,8	1840	1	6

### ERSATZTEIL

+ PTFE	<b>7406-0</b> 67x11mm
	<b>7407-0</b> 45x11mm
	<b>7409-0</b> 51x11mm

\*Verpackungsoptionen: gerade Referenzen, weiße Schachtel / ungerade Referenzen, bedruckte Schachtel

ROHRABSCHNEIDER

---

# Für dünnwandige Metallrohre.

Zukunftsorientiert denken →

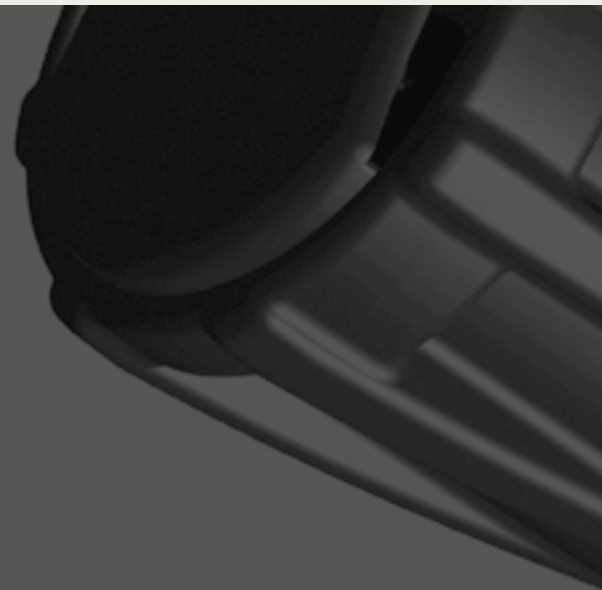

ZENTEN

06.



# basick+

Ø 1/8" - 5/8"  
3-16 mm



ZENTEN  
42

## MERKMALE



**Resistent**  
Stahlgelagerte Spindel.



**Komfort**  
Ergonomischer Drehknäuf.







**Sofortiger**  
ICS-System (Instant Change System).  
Klingen-Schnellwechsel ohne Werkzeug.



**Lösung**  
Mit extrem reduziertem Arbeitsradius.





### Al, Cu und Inox (MAX. 2 mm)

Ref.	Ext. Ø mm		 gr	Verpackung		
7016-0	3-16	1x	105	Lose	50	150
7016-1	3-16	1x	110	SB	10	100
7316-0	3-16	1x	105	Lose	50	150
7316-1	3-16	1x	110	SB	10	100

### ERSATZTEIL



### AL, CU (MAX. 2 mm)

Ref.	Ext. Ø mm		 gr	Verpackung		
7016-2	3-16	1x	105	Lose	50	150
7016-3	3-16	1x	110	SB	10	100
7316-2	3-16	1x	105	Lose	50	150
7316-3	3-16	1x	110	SB	10	100

### ERSATZTEIL





# basick+

Ø 1/8" - 1"  
3-25 mm



## MERKMALE



**Resistent**  
Stahlgelagerte Spindel.



**Komfort**  
Ergonomischer Drehknopf.







**Sofortiger**  
ICS-System (Instant Change System).  
Klingen-Schnellwechsel ohne Werkzeug.



**Lösung**  
Mit extrem reduziertem Arbeitsradius.

### Al, Cu und Inox (MAX. 2 mm)

Ref.	Ext. Ø mm			Verpackung		
7025-0	3-25	1x	140	Lose	30	120
7025-1	3-25	1x	145	SB	10	100
7325-0	3-25	1x	140	Lose	30	120
7325-1	3-25	1x	145	SB	10	100

### ERSATZTEIL







**6001-0**  
19x5mm



**6005-0**  
19x6,20mm

### AL, CU (MAX. 2 mm)

Ref.	Ext. Ø mm			Verpackung		
7025-2	3-25	1x	140	Lose	30	120
7025-3	3-25	1x	145	SB	10	100
7325-2	3-25	1x	140	Lose	30	120
7325-3	3-25	1x	145	SB	10	100

### ERSATZTEIL



**6008-0**  
19x5mm



**6009-0**  
19x6,20mm

# basick+

Ø 1/8" - 1 1/8"  
3-30 mm

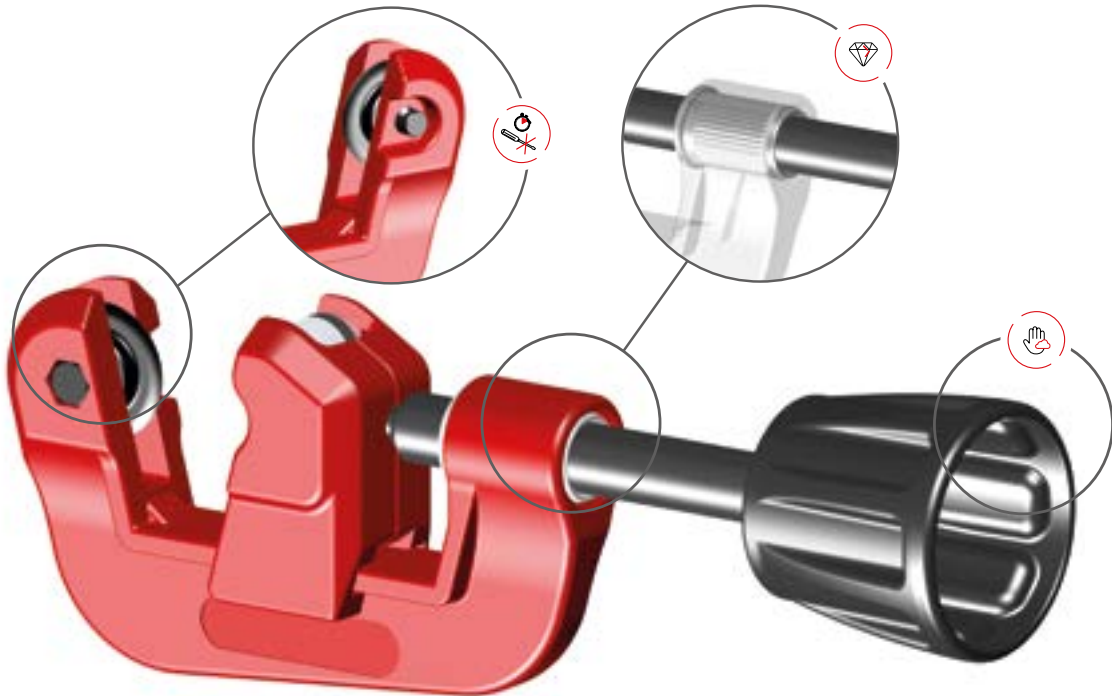

## MERKMALE



**Resistent**  
Stahlgelagerte Spindel.



**Komfort**  
Ergonomischer Drehknäuf.



**Sofortiger**  
ICS-System (Instant Change System).  
Klingen-Schnellwechsel ohne Werkzeug.





### Al, Cu und Inox (MAX. 2 mm)

Ref.	Ext. Ø mm			Verpackung		
7030-0	3-30	1x	340	Lose	10	40
7030-1	3-30	1x	350	SB	5	50
7330-0	3-30	1x	340	Lose	10	40
7330-1	3-30	1x	350	SB	5	50

### ERSATZTEIL



### AL, CU (MAX. 2 mm)

Ref.	Ext. Ø mm			Verpackung		
7030-2	3-30	1x	340	Lose	10	40
7030-3	3-30	1x	350	SB	5	50
7330-2	3-30	1x	340	Lose	10	40
7330-3	3-30	1x	350	SB	5	50

### ERSATZTEIL



basick+

Ø 1/8" - 1.3/8"  
3-35 mm

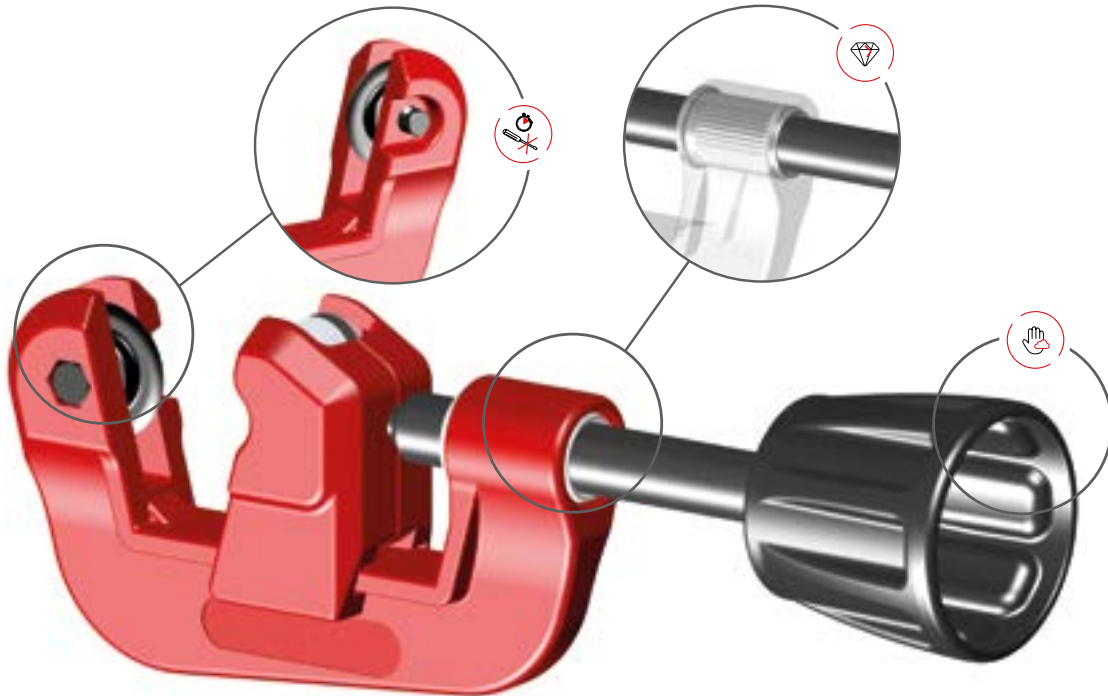

MERKMALE



**Resistent**  
Stahlgelagerte Spindel.







**Komfort**  
Ergonomischer Drehknopf.



**Sofortiger**  
ICS-System (Instant Change System).  
Klingen-Schnellwechsel ohne Werkzeug.





Al, Cu und Inox (MAX. 2 mm)

Ref.	Ext. Ø mm			Verpackung		
7035-0	3-35	1x	345	Lose	10	40
7035-1	3-35	1x	355	SB	5	50
7335-0	3-35	1x	345	Lose	10	40
7335-1	3-35	1x	355	SB	5	50

ERSATZTEIL



AL, CU (MAX. 2 mm)

Ref.	Ext. Ø mm			Verpackung		
7035-2	3-35	1x	345	Lose	10	40
7035-3	3-35	1x	355	SB	5	50
7335-2	3-35	1x	345	Lose	10	40
7335-3	3-35	1x	355	SB	5	50

ERSATZTEIL



# basick+

Ø 1/8" - 1.3/8"  
3-35 mm



## MERKMALE



**Resistent**  
Stahlgelagerte Spindel.



**Komfort**  
Ergonomischer Drehknopf.



**Sofortiger**  
ICS-System (Instant Change System).  
Klingen-Schnellwechsel ohne Werkzeug.



**Lösung**  
Mit extrem reduziertem Arbeitsradius.







Al, Cu und Inox (MAX. 2 mm)

Ref.	Ext. Ø mm		 gr	Verpackung 		
7036-0	3-35	1x	385	Lose	10	40
7036-1	3-35	1x	395	SB	5	50
7336-0	3-35	1x	385	Lose	10	40
7336-1	3-35	1x	395	SB	5	50

ERSATZTEIL



AL, CU (MAX. 2 mm)

Ref.	Ext. Ø mm		 gr	Verpackung 		
7036-2	3-35	1x	385	Lose	10	40
7036-3	3-35	1x	395	SB	5	50
7336-2	3-35	1x	385	Lose	10	40
7336-3	3-35	1x	395	SB	5	50

ERSATZTEIL



# kompakt+

Ø 1/8" - 1.1/8"  
3-30 mm



## MERKMALE



**Resistent**  
Stahlgelagerte Spindel.



**Komfort**  
Ergonomischer Drehknopf.



**Lösung**  
Mit extrem reduziertem Arbeitsradius.



**Sofortiger**  
ICS-System (Instant Change System).  
Klingen-Schnellwechsel ohne Werkzeug.



**Handlich**  
Ersatzrädchen in Drehknopf-Kappe.

### Al, Cu und Inox (MAX. 2 mm)

Ref.	Ext. Ø mm			Verpackung		
6230-0	3-30	2x	215	Lose	25	100
6230-1	3-30	2x	220	SB	10	100
6430-0	3-30	2x	215	Lose	25	100
6430-1	3-30	2x	220	SB	10	100

### AL, CU (MAX. 2 mm)

#### ERSATZTEIL

	<b>6001-0</b> 19x5mm
	<b>6005-0</b> 19x6,20mm

Ref.	Ext. Ø mm			Verpackung		
6230-2	3-30	2x	215	Lose	25	100
6230-3	3-30	2x	220	SB	10	100
6430-2	3-30	2x	215	Lose	25	100
6430-3	3-30	2x	220	SB	10	100

#### ERSATZTEIL

	<b>6008-0</b> 19x5mm
	<b>6009-0</b> 19x6,20mm

# kompakt+

Ø 1/8" - 1.3/8"  
3-35 mm

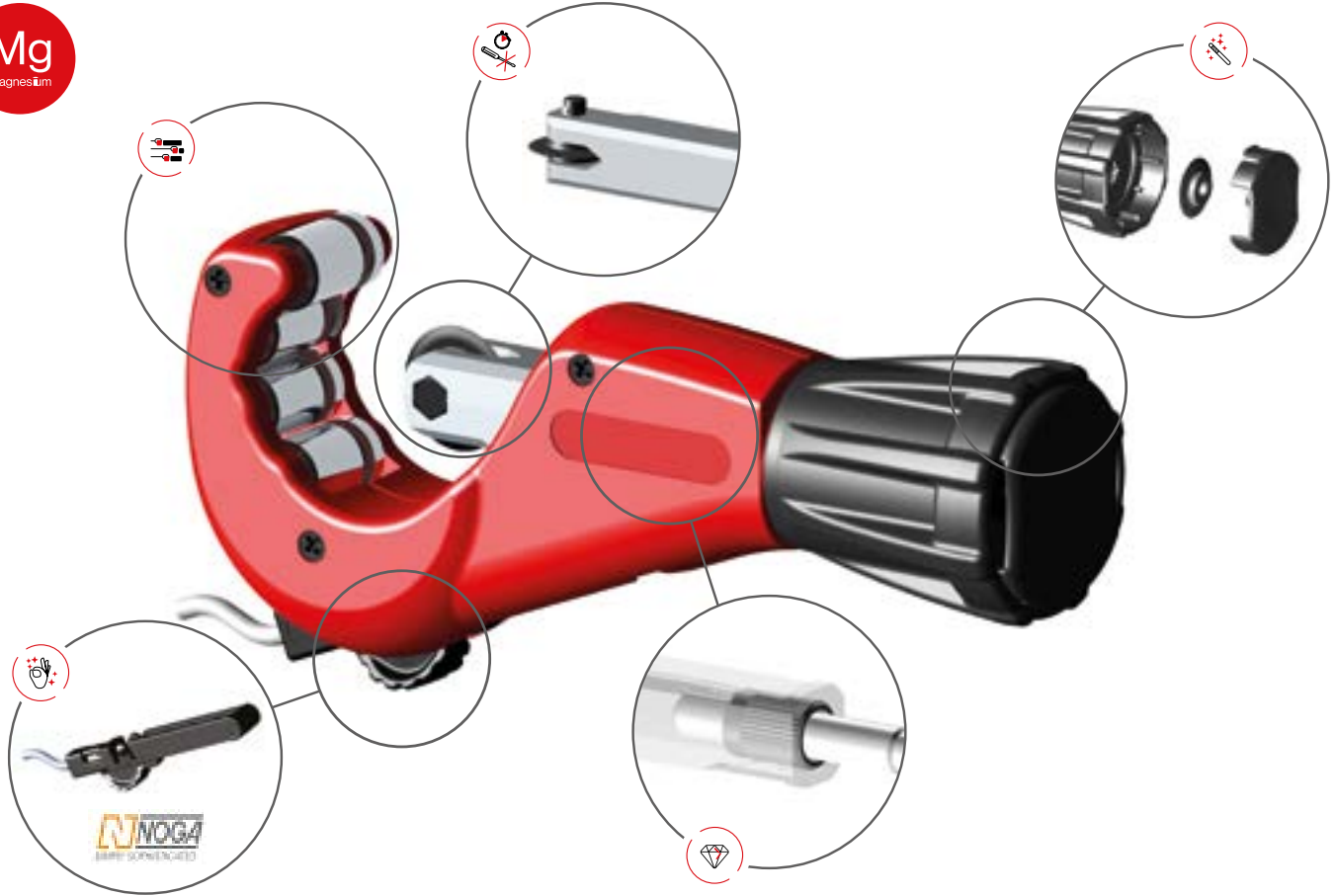

## MERKMALE



**Resistent**  
Stahlgelagerte Spindel.



**Stabil**  
4 Führungsrollen für einen optimalen Halt des Rohres.



**Handlich**  
Ersatzrädchen in Drehknopf-Kappe.



**Sofortiger**  
ICS-System (Instant Change System). Klingen-Schnellwechsel ohne Werkzeug.



**Praktisch**  
NOGA Entgrater-Klinge. Kann komplett herausgezogen werden.

### Al, Cu und Inox (MAX. 2 mm)

Ref.	Ext. Ø mm		gr.	Verpackung		
7135-0	3-35	2x	335	Lose	10	40
7135-1	3-35	2x	345	SB	3	30
7435-0	3-35	2x	335	Lose	10	40
7435-1	3-35	2x	345	SB	3	30

### ERSATZTEIL



### AL, CU (MAX. 2 mm)

Ref.	Ext. Ø mm		gr.	Verpackung		
7135-2	3-35	2x	335	Lose	10	40
7135-3	3-35	2x	345	SB	3	30
7435-2	3-35	2x	335	Lose	10	40
7435-3	3-35	2x	345	SB	3	30

### ERSATZTEIL







Für dünnwandige  
Metallrohre.

MODELL 7145

# kompakt+

Ø 1/8" - 1.3/4"  
3-45 mm

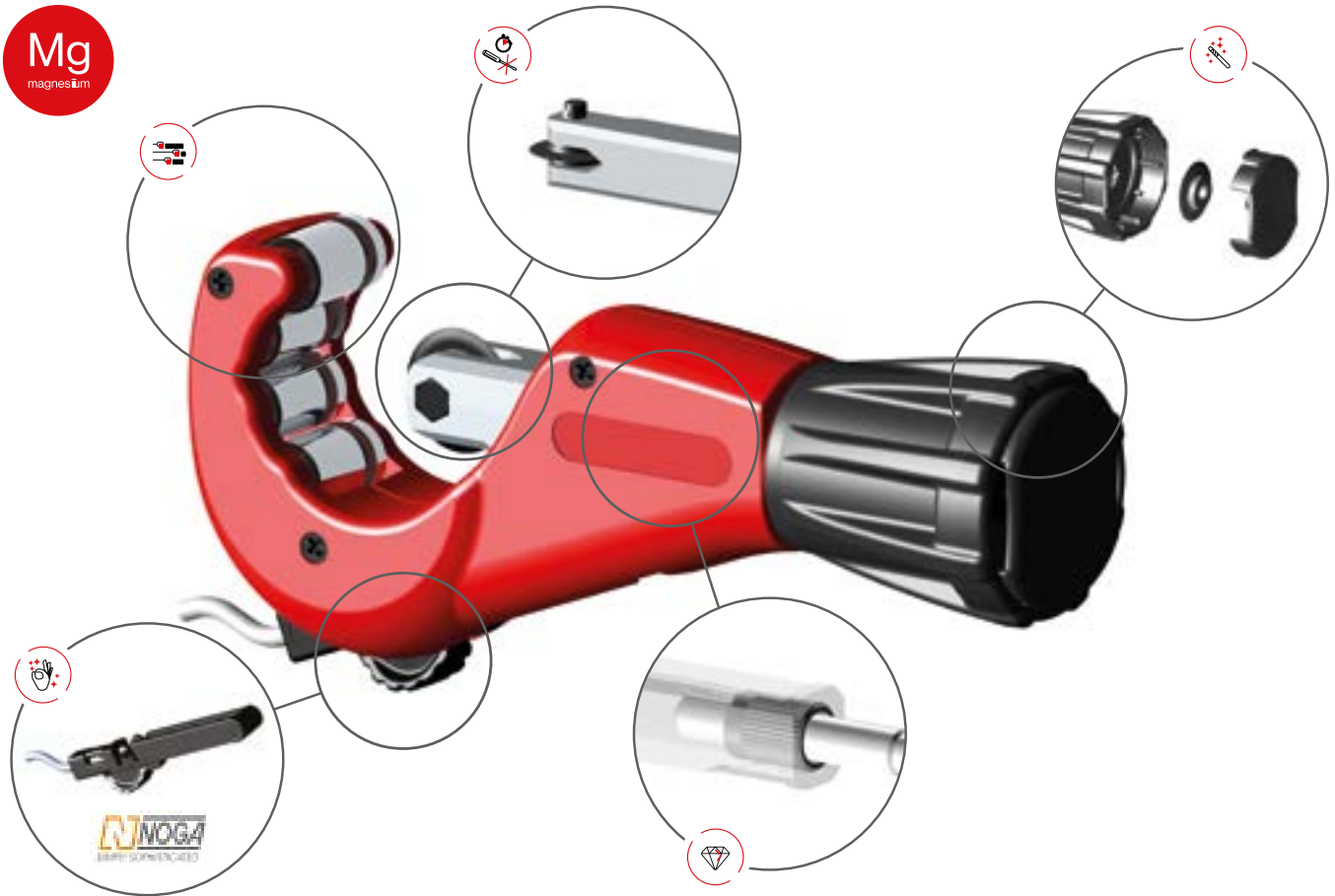

## MERKMALE



### Resistent

Stahlgelagerte Spindel.



### Stabil

4 Führungsrollen für einen optimalen Halt des Rohres.



### Handlich

Ersatzrädchen in Drehknopf-Kappe.



### Sofortiger

ICS-System (Instant Change System). Klingen-Schnellwechsel ohne Werkzeug.



### Praktisch

NOGA Entgrater-Klinge. Kann komplett herausgezogen werden.

## Al, Cu und Inox (MAX. 2 mm)

Ref.	Ext. Ø mm		gr.	Verpackung		
7145-0	3-45	2x	355	Lose	5	50
7145-1	3-45	2x	365	SB	3	30

## ERSATZTEIL



## AL, CU (MAX. 2 mm)

Ref.	Ext. Ø mm		gr.	Verpackung		
7145-2	3-30	2x	355	Lose	5	50
7145-3	3-30	2x	365	SB	3	30

## ERSATZTEIL





# kompakt+ quick

Ø1/4" - 2.1/6"  
6-54mm

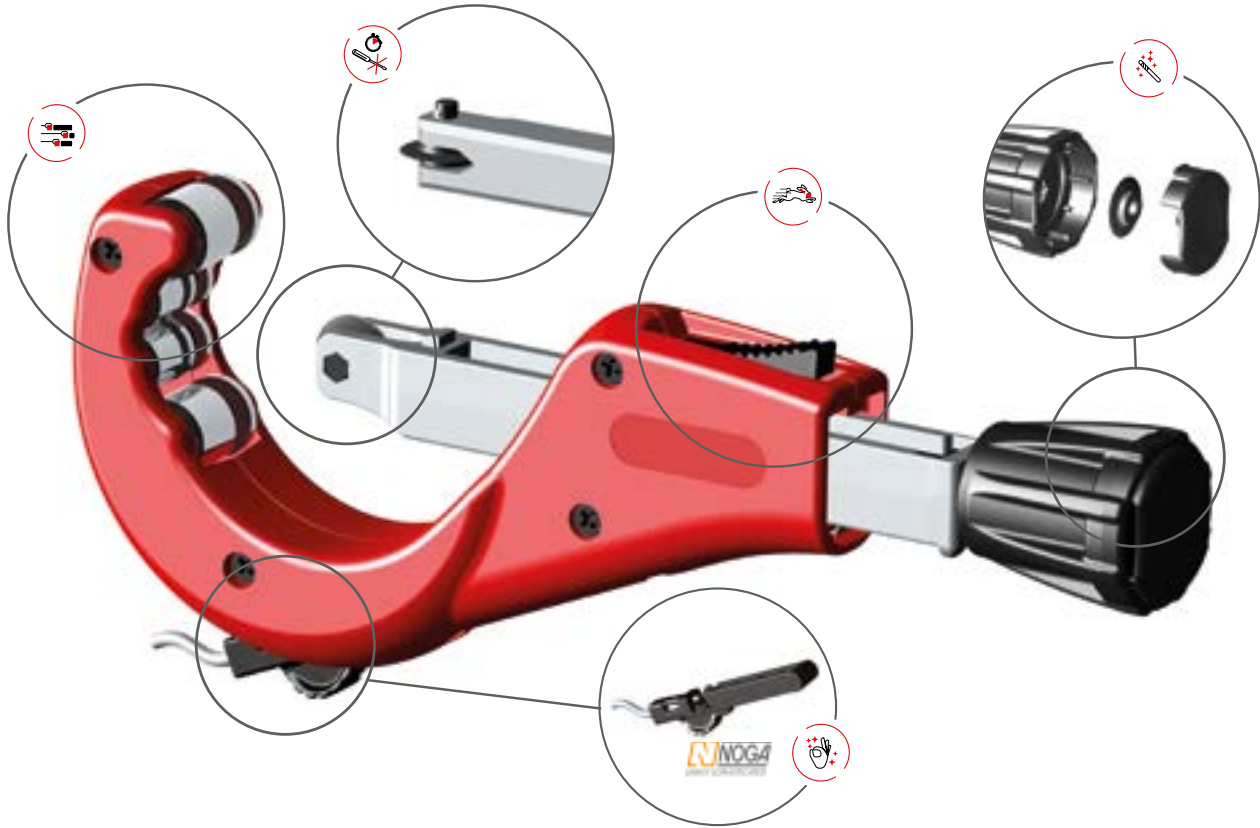

## MERKMALE



### Schnell

Schnell-Vorschub System.



### Praktisch

NOGA Entgrater-Klinge. Kann komplett herausgezogen werden.



### Sofortiger

ICS-System (Instant Change System).  
Klingen-Schnellwechsel ohne Werkzeug.



### Handlich

Ersatzrädchen in Drehknopf-Kappe.



### Stabil

4 Führungsrollen für einen optimalen  
Halt des Rohres.

Al, Cu und Inox (MAX. 2 mm)

Ref.	Ext. Ø mm			Verpackung		
7454-0	6-54	2x	720	Lose	1	15
7454-1	6-54	2x	740	SB	-	12

ERSATZTEIL



**6005-0**  
19x6,20mm

AL, CU (MAX. 2 mm)

Ref.	Ext. Ø mm			Verpackung		
7454-2	6-54	2x	720	Lose	1	15
7454-3	6-54	2x	740	SB	-	12

ERSATZTEIL



**6009-0**  
19x6,20mm

# kompakt+ quick

Ø 1/4" - 3"  
6-76 mm

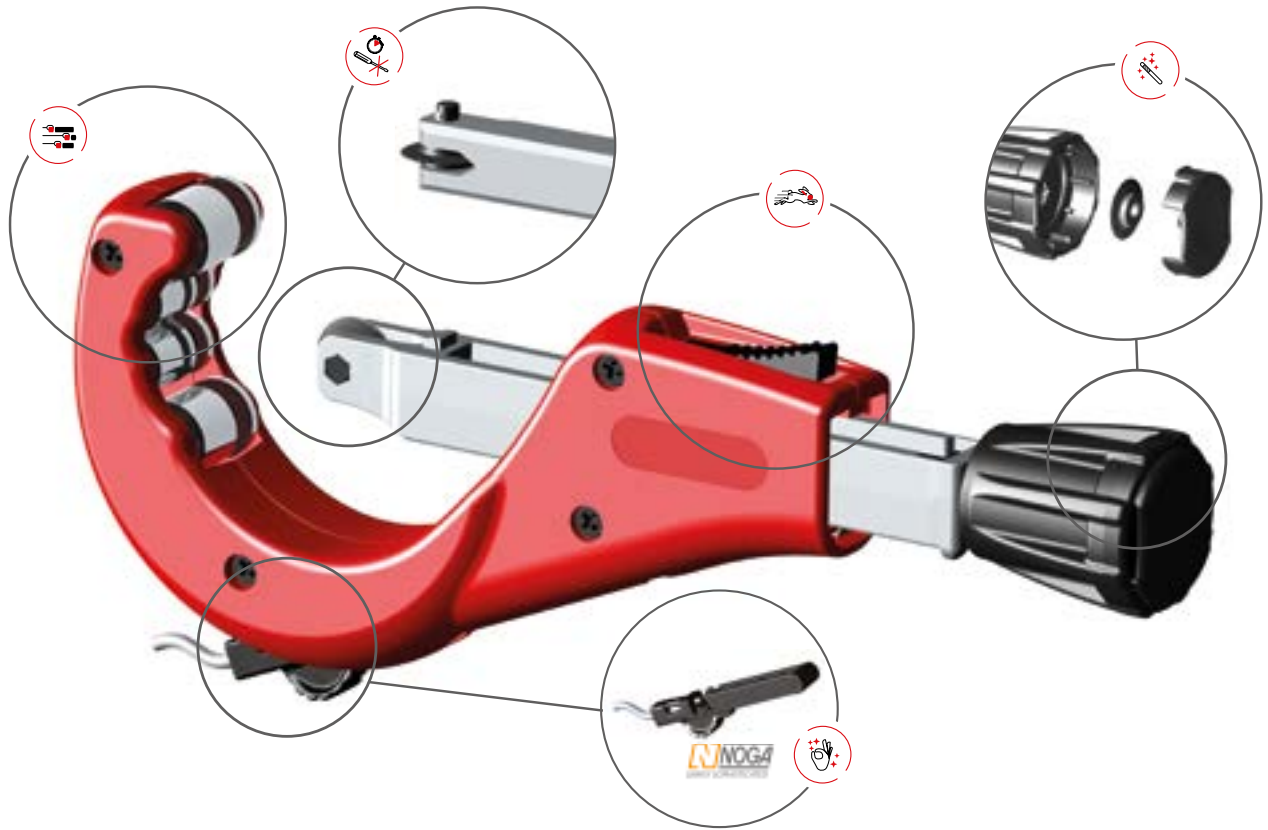

## MERKMALE



### Schnell

Schnell-Vorschub System.



### Praktisch

NOGA Entgrater-Klinge. Kann komplett herausgezogen werden.



### Sofortiger

ICS-System (Instant Change System).  
Klingen-Schnellwechsel ohne Werkzeug.



### Handlich





Ersatzrädchen in Drehknopf-Kappe.



### Stabil

4 Führungsrollen für einen optimalen Halt des Rohres.

Al, Cu und Inox (MAX. 2 mm)





Ref.	Ext. Ø mm			Verpackung		
7476-0	6-76	2x	880	Lose	1	15
7476-1	6-76	2x	905	SB	-	12

ERSATZTEIL



**6005-0**  
19x6,20mm

AL, CU (MAX. 2 mm)

Ref.	Ext. Ø mm			Verpackung		
7476-2	6-76	2x	880	Lose	1	15
7476-3	6-76	2x	905	SB	-	12

ERSATZTEIL



**6009-0**  
19x6,20mm

# kompakt+ quick

Ø 2" - 5"  
50-127 mm

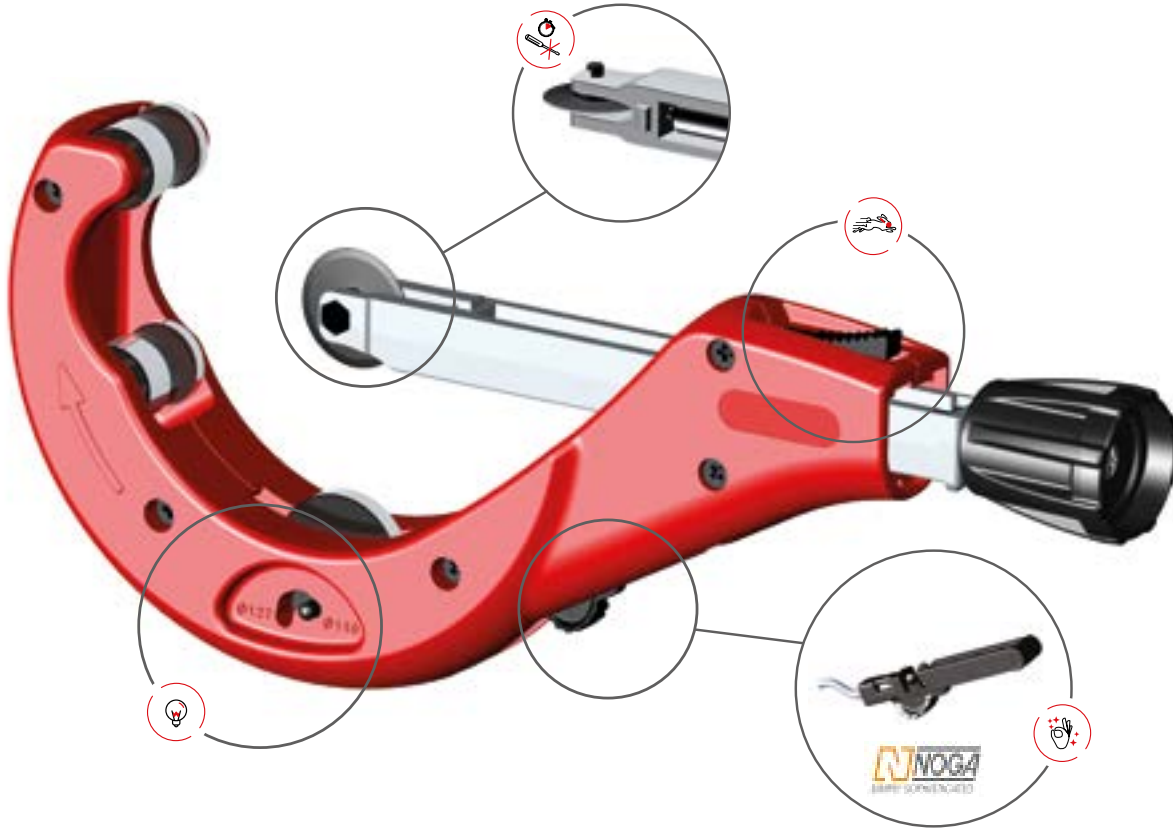

ZENTEN  
Brennstoff  
Druck

52

## MERKMALE



### Lösung

In zwei Positionen (110mm und 127mm) verstellbare dritte Führungsrolle für eine optimale Führung des Rohres beim Schneiden.

- Position 110mm: Zum Schneiden von Rohren bis inklusive 110mm.
- Position 127mm: Zum Schneiden von Rohren ab 110mm und bis 127mm.



### Sofortiger

ICS-System (Instant Change System).  
Klingen-Schnellwechsel ohne Werkzeug.



### Schnell

Schnell-Vorschub System.



### Praktisch

NOGA Entgrater-Klinge. Kann komplett herausgezogen werden.

AL, CU (MAX. 6mm)

Ref.	Ext. Ø mm			Verpackung		
7477-0	50-127	1x	1620	Weißer Schachtel	1	6
7477-1	50-127	1x	1620	Bedruckte Schachtel	1	6

ERSATZTEIL



**7402-0**  
25x11mm

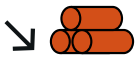

Für dünnwandige  
Metallrohre.

MODELL 7478

# kompakt+ quick

Ø 4" - 6.5/8"  
100-170 mm

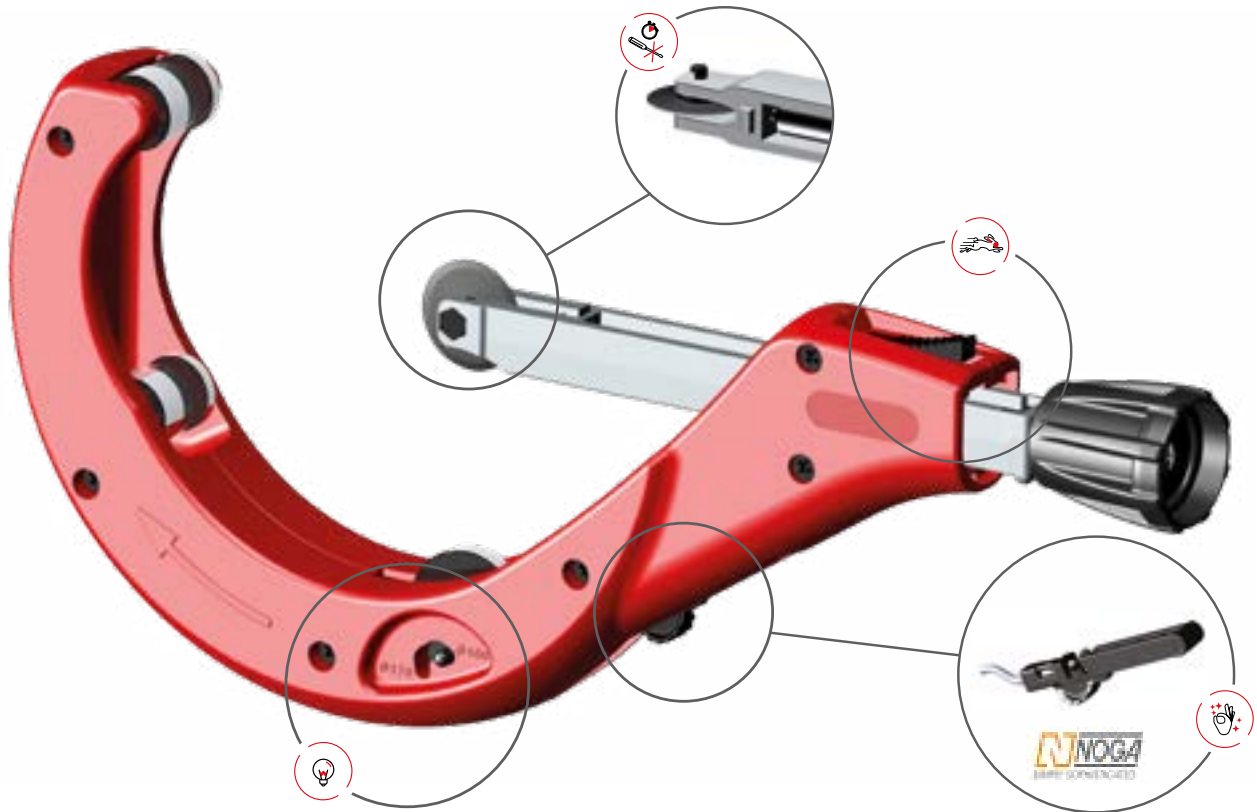

ZENTEN

53

## MERKMALE



### Lösung

In zwei Positionen (160mm und 170mm) verstellbare dritte Führungsrolle für eine optimale Führung des Rohres beim Schneiden.

- Position 160mm: Zum Schneiden von Rohren bis inklusive 160mm.
- Position 170mm: Zum Schneiden von Rohren ab 160mm und bis 170mm.



### Sofortiger

ICS-System (Instant Change System).  
Klingen-Schnellwechsel ohne Werkzeug.



### Schnell

Schnell-Vorschub System.



### Praktisch

NOGA Entgrater-Klinge. Kann komplett herausgezogen werden.

AL, CU (MAX. 6mm)

Ref.	Ext. Ø mm			Verpackung		
7478-0	100-170	1x	1830	Weißer Schachtel	1	6
7478-1	100-170	1x	1830	Bedruckte Schachtel	1	6

## ERSATZTEIL



**7402-0**  
25x11mm

ROHRABSCHNEIDER

---

# Für Inox Rohre

Zukunftsorientiert denken —————>

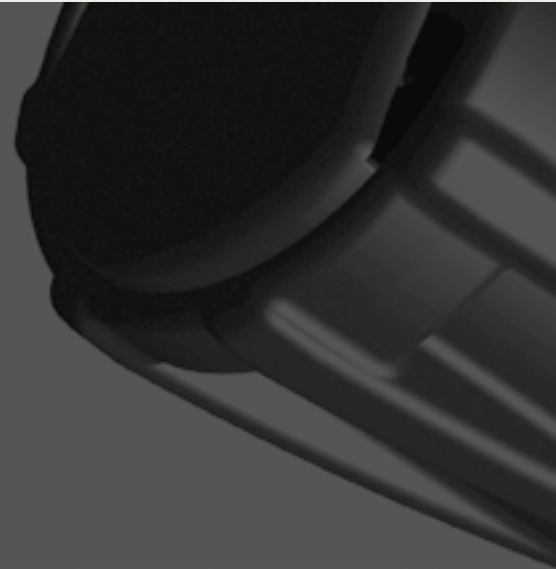

ZENTEN

07.





# inox kompakt+

Ø 1/8" - 1 1/8"  
3-30 mm

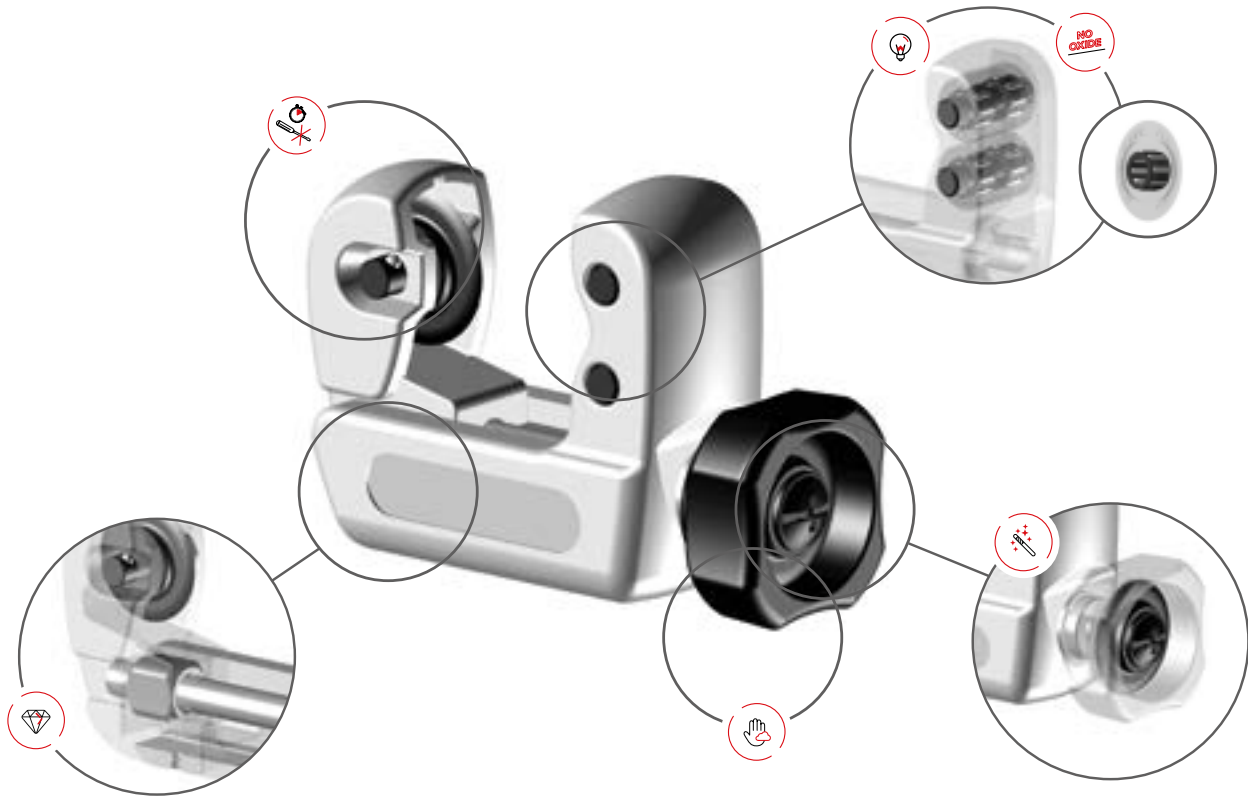

ZENTEN Brandmark

56

## MERKMALE



**Resistent**  
Stahlgelagerte Spindel.



**Kein Oxid**  
Führungsrollen aus INOX-Stahl.



**Sofortiger**  
ICS-System (Instant Change System).  
Schneidrädchen-Schnellwechsel ohne Werkzeug.



**Komfort**  
Ergonomischer Drehknopf.



**Lösung**  
Nadelgelagerte Führungsrollen und Schneidrädchen.



**Handlich**  
Ersatzrädchen im Drehknopf.



### INOX (MAX. 2mm)

Ref.	Ext. Ø mm			Verpackung		
7230-0	3-30	2x	215	Lose	25	100
7230-1	3-30	2x	220	SB	10	100

### ERSATZTEIL



**6001-8**  
19x5mm

### INOX (MAX. 2mm)

Ref.	Ext. Ø mm			Verpackung		
7530-0	3-30	2x	215	Lose	25	100
7530-1	3-30	2x	220	SB	10	100

### ERSATZTEIL



**6005-8**  
19x6,2mm

# inox kompakt+

Ø 1/8" - 1.3/8"  
3-35 mm

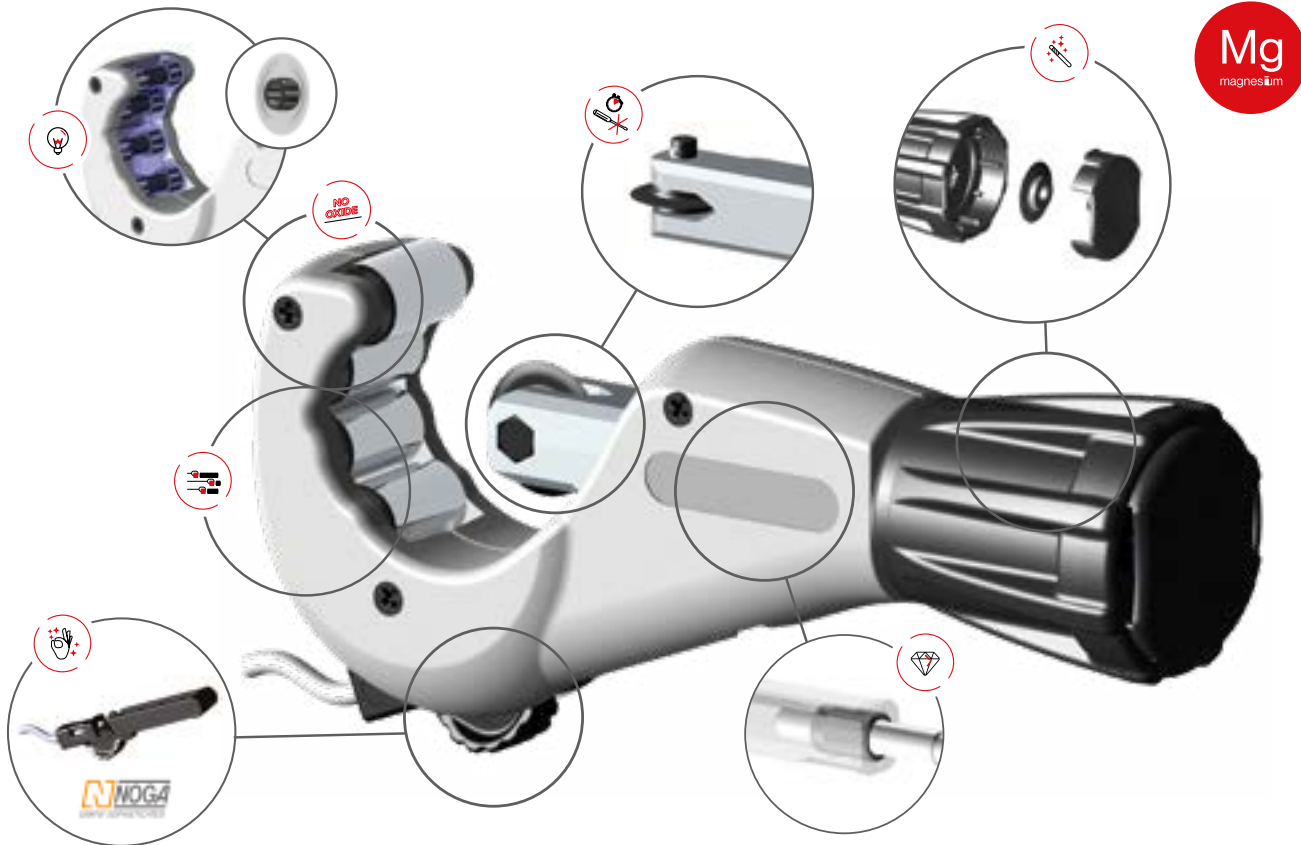





**Mg**  
magnesium

## MERKMALE

- 
**Resistent**  
Stahlgelagerte Spindel.
- 
**Stabil**  
4 Führungsrollen für einen optimalen Halt des Rohres.
- 
**Handlich**  
Ersatzrädchen im Drehknopf.
- 
**Lösung**  
Nadelgelagerte Führungsrollen und Schneidrädchen.
- 
**Kein Oxid**  
Führungsrollen aus INOX-Stahl.
- 
**Sofortiger**  
ICS-System (Instant Change System).  
Klingen-Schnellwechsel ohne Werkzeug.
- 
**Praktisch**  
NOGA Entgrater-Klinge. Kann komplett herausgezogen werden.

### INOX (MAX. 2mm)





Ref.	Ext. Ø mm			Verpackung		
7235-0	3-35	2x	335	Lose	10	40
7235-1	3-35	2x	345	SB	3	30

### ERSATZTEIL



**6001-8**  
19x5mm

### INOX (MAX. 2mm)

Ref.	Ext. Ø mm			Verpackung		
7535-0	3-35	2x	335	Lose	10	40
7535-1	3-35	2x	345	SB	3	30

### ERSATZTEIL



**6005-8**  
19x6,2mm

# inox kompakt+

Ø 1/8" - 1.3/4"  
3-45 mm

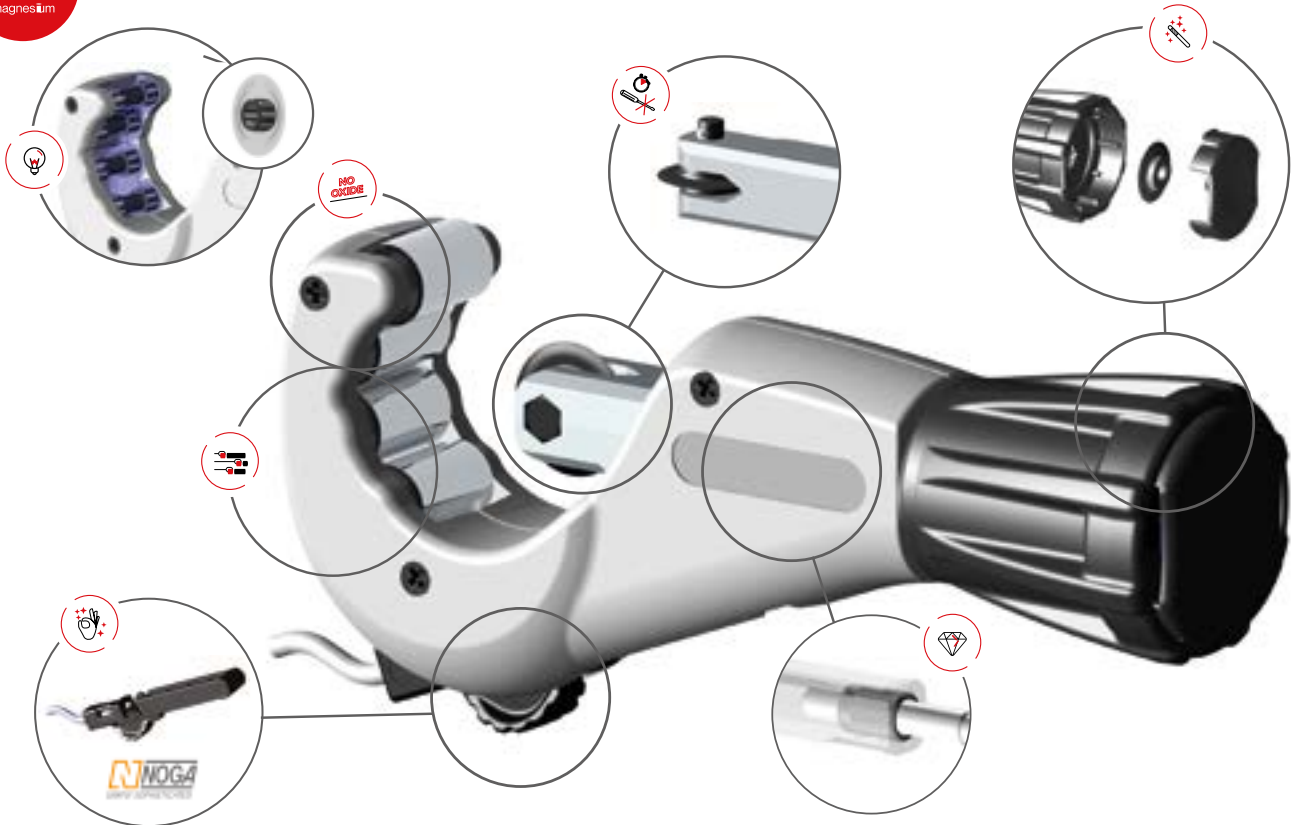

ZENTEN Brandspindel System  
58

## MERKMALE



**Resistent**  
Stahlgelagerte Spindel.



**Stabil**  
4 Führungsrollen für einen optimalen Halt des Rohres.



**Handlich**  
Ersatzrädchen im Drehknopf.



**Lösung**  
Nadelgelagerte Führungsrollen und Schneidrädchen.



**Kein Oxid**  
Führungsrollen aus INOX-Stahl.







**Sofortiger**  
ICS-System (Instant Change System). Klingen-Schnellwechsel ohne Werkzeug.



**Praktisch**  
NOGA Entgrater-Klinge. Kann komplett herausgezogen werden.

### INOX (MAX. 2mm)





Ref.	Ext. Ø mm			Verpackung		
7245-0	3-45	2x	355	Lose	5	50
7245-1	3-45	2x	365	SB	3	30

### ERSATZTEIL



**6001-8**  
19x5mm

### INOX (MAX. 2mm)

Ref.	Ext. Ø mm			Verpackung		
7545-0	3-45	2x	355	Lose	5	50
7545-1	3-45	2x	365	SB	3	30

### ERSATZTEIL



**6005-8**  
19x6,2mm

# inox kompakt+ quick

Ø 1/4" - 2.1/6"  
6-54 mm

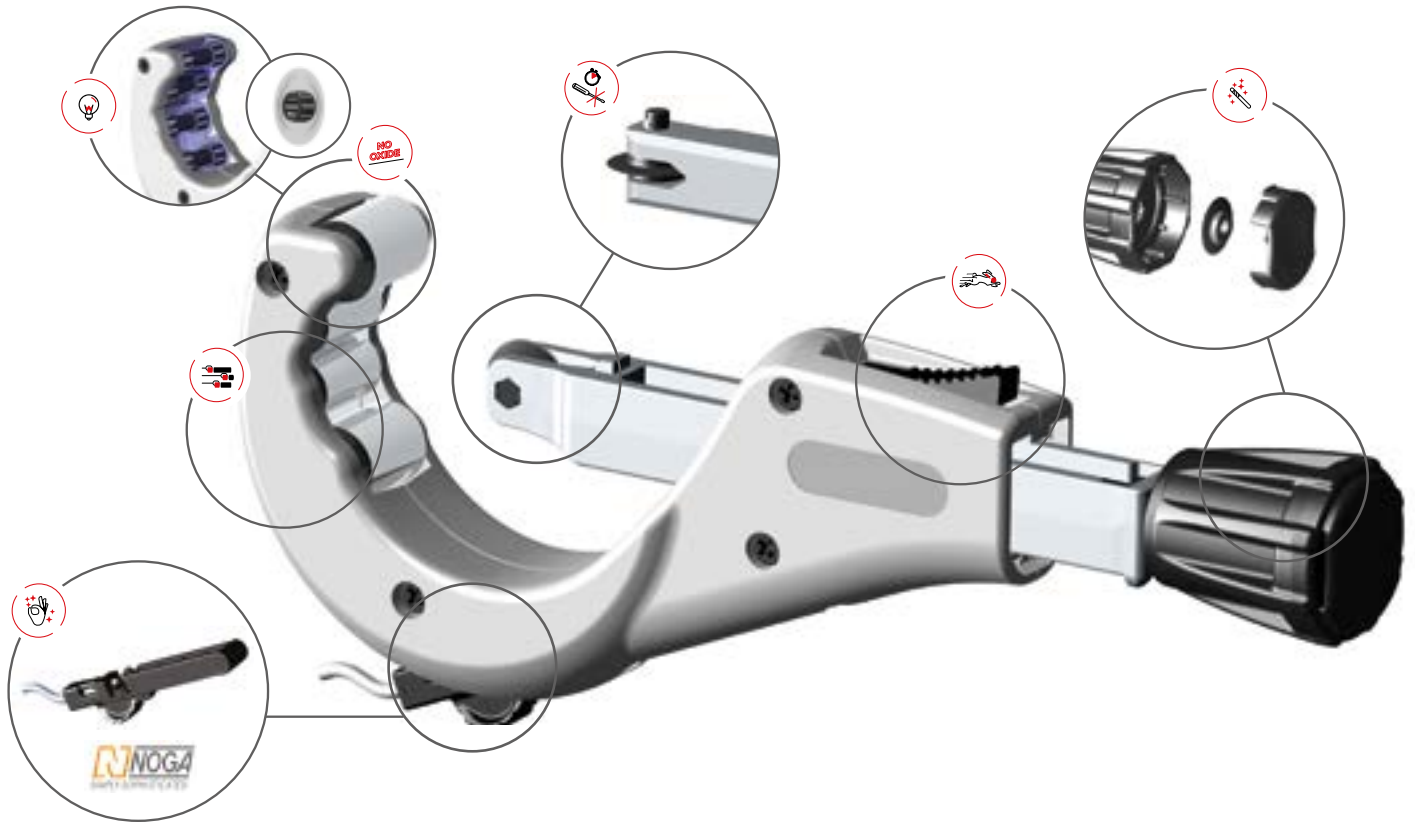

ZENTEN

## MERKMALE

 **Schnell**  
Schnell-Vorschub System.

 **Stabil**  
4 Führungsrollen für einen optimalen Halt des Rohres.

 **Handlich**  
Spare cutting wheel on the cap of the knob.





 **Lösung**  
Nadelgelagerte Führungsrollen und Schneidrädchen.

 **Kein Oxid**  
Führungsrollen aus INOX-Stahl.

 **Sofortiger**  
ICS-System (Instant Change System). Klingen-Schnellwechsel ohne Werkzeug.

 **Praktisch**  
NOGA Entgrater-Klinge. Kann komplett herausgezogen werden.

## INOX (MAX. 2mm)

Ref.	Ext. Ø mm			Verpackung		
7554-0	6-54	2x	720	Lose	1	15
7554-1	6-54	2x	740	SB	-	12

## ERSATZTEIL



**6005-8**  
19x6,2mm

# inox kompakt+ quick

Ø 1/4" - 3"  
6-76 mm

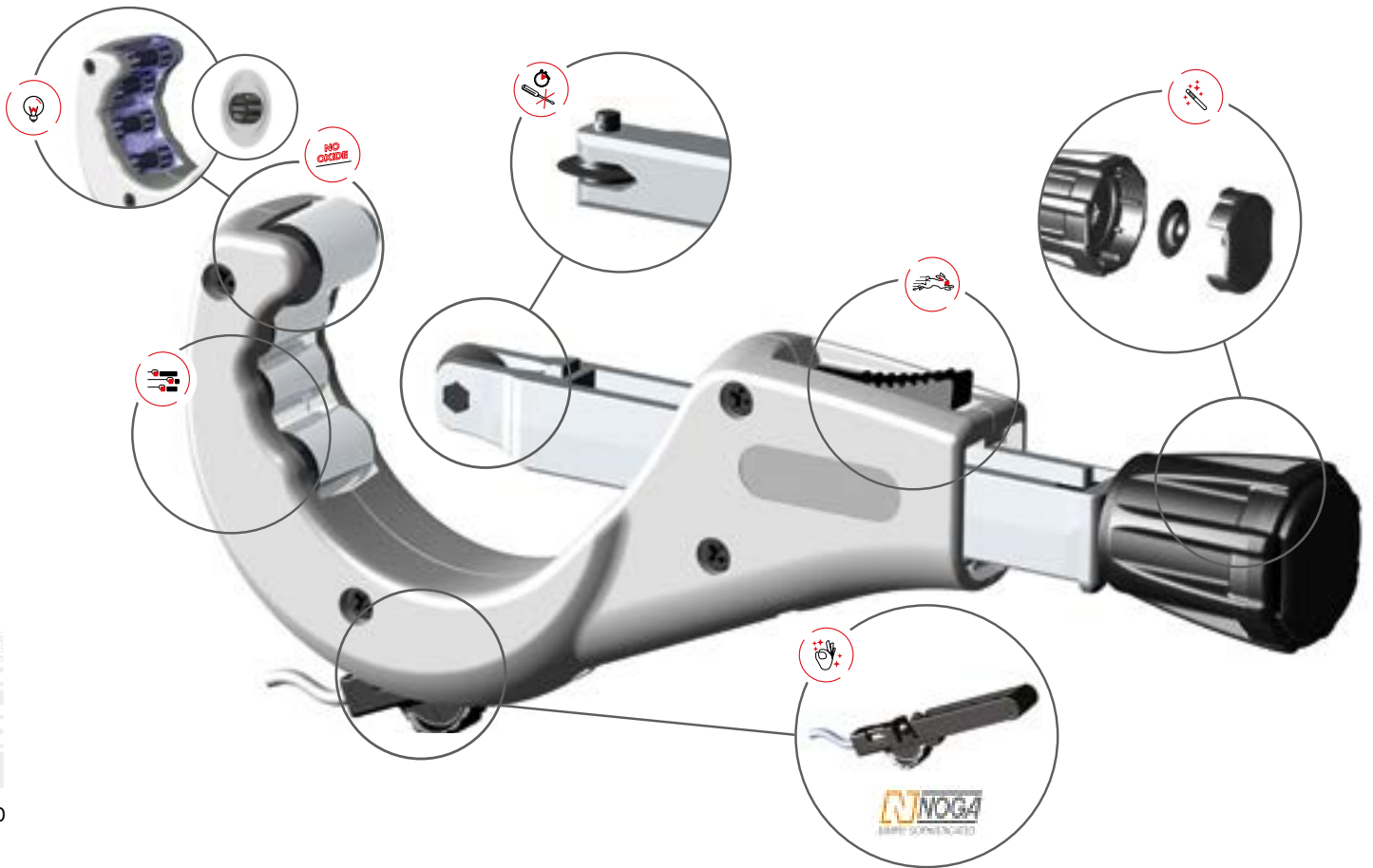

## MERKMALE



### Schnell

Schnell-Vorschub System.



### Stabil

4 Führungsrollen für einen optimalen Halt des Rohres.



### Handlich

Ersatzrädchen im Drehknopf.



### Lösung

Nadelgelagerte Führungsrollen und Schneidrädchen.



### Kein Oxid

Führungsrollen aus INOX-Stahl.



### Sofortiger





ICS-System (Instant Change System). Klingen-Schnellwechsel ohne Werkzeug.



### Praktisch

NOGA Entgrater-Klinge. Kann komplett herausgezogen werden.

## INOX (MAX. 2mm)

Ref.	Ext.Ø mm			Verpackung		
7576-0	6-76	2x	880	Lose	1	15
7576-1	6-76	2x	905	SB	-	12

## ERSATZTEIL



**6005-8**  
19x6,2mm

**BG Services**  
BY **ZENTEN**



ROHRABSCHNEIDER

---

# Für Stahl- und Inox Rohre

Zukunftsorientiert denken —————→

ZENTEN

08.



# maxtc

Ø 1/8" - 1 1/4"  
10-42 mm

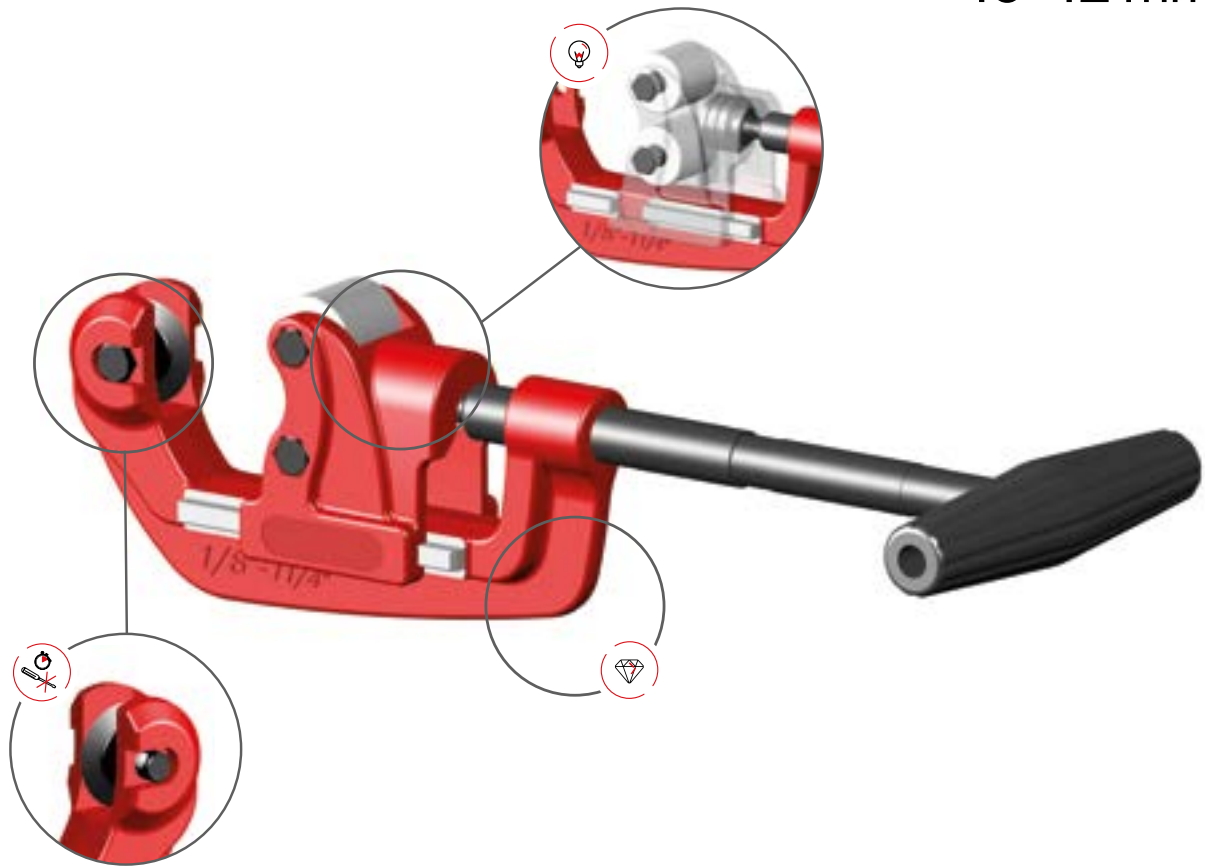

## MERKMALE



**Resistent**  
Stahlgeschmiedeter Körper.



**Sofortiger**  
ICS-System (Instant Change System).  
Klingen-Schnellwechsel ohne Werkzeug.



**Lösung**  
Feder-Andrucksystem: Garantiert verbesserten Schnitt  
und längere Gebrauchsdauer des Schneidrädchens.

## STAHL- UND INOX(MAX. 5,5 mm)

Ref.	Ext. Ø mm			Verpackung		
6042-1	10-42	1x	1200	Bedruckte Schachtel	1	8

## ERSATZTEIL



**6014-0**  
25x14mm

# maxtc

Ø 1/8" - 2"  
10-60 mm

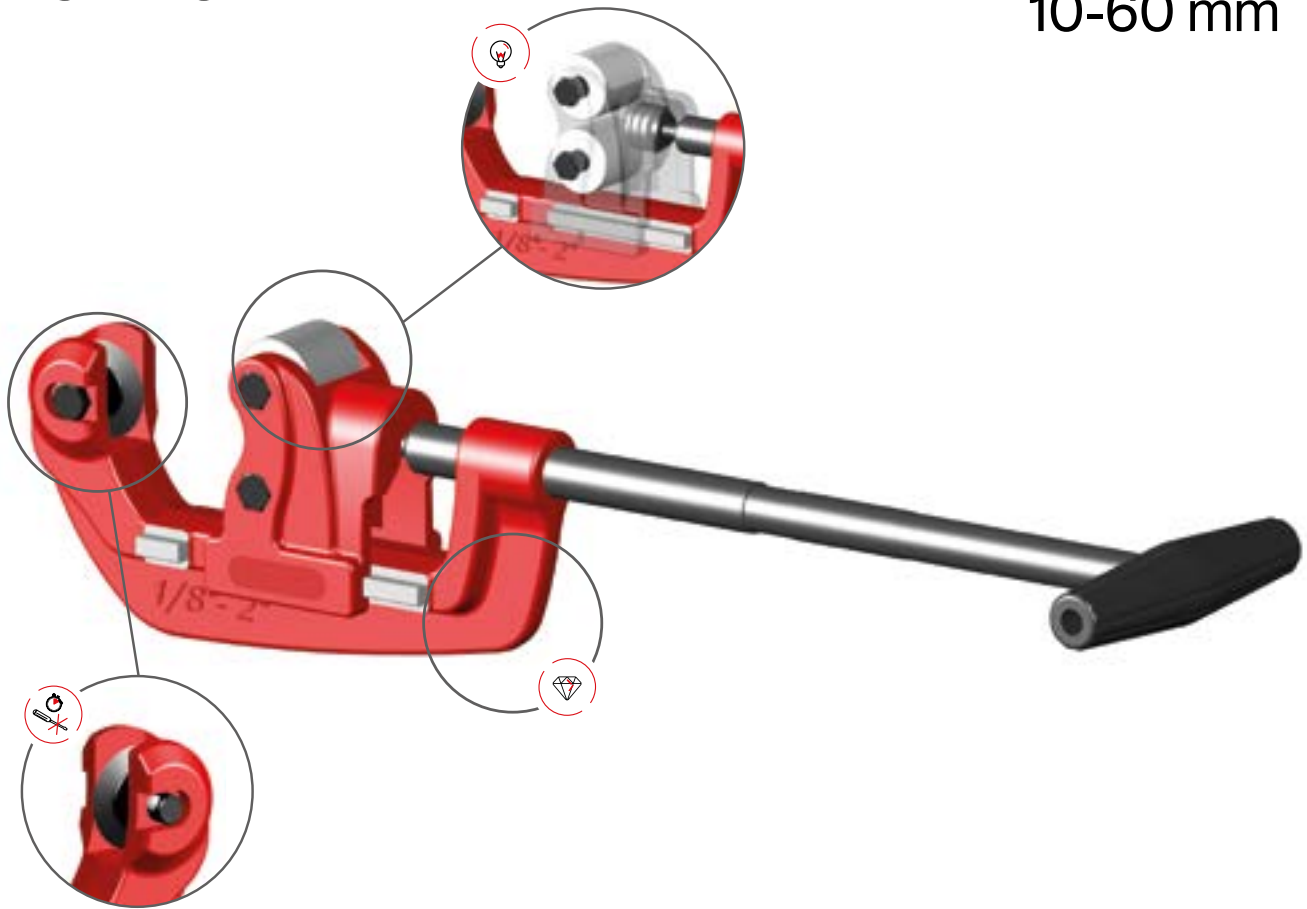

## MERKMALE



**Resistent**  
Stahlgeschmiedeter Körper.







**Sofortiger**  
ICS-System (Instant Change System).  
Klingen-Schnellwechsel ohne Werkzeug.



**Lösung**  
Feder-Andrucksystem: Garantiert verbesserten Schnitt  
und längere Gebrauchsdauer des Schneidrädchens.

## STAHL- UND INOX(MAX. 7,0 mm)

Ref.	Ext. Ø mm			Verpackung		
6050-1	10-60	1x	2250	Bedruckte Schachtel	1	6

## ERSATZTEIL



**6002-0**  
31x19mm

# maxtc

Ø 2" - 4"  
60-114 mm

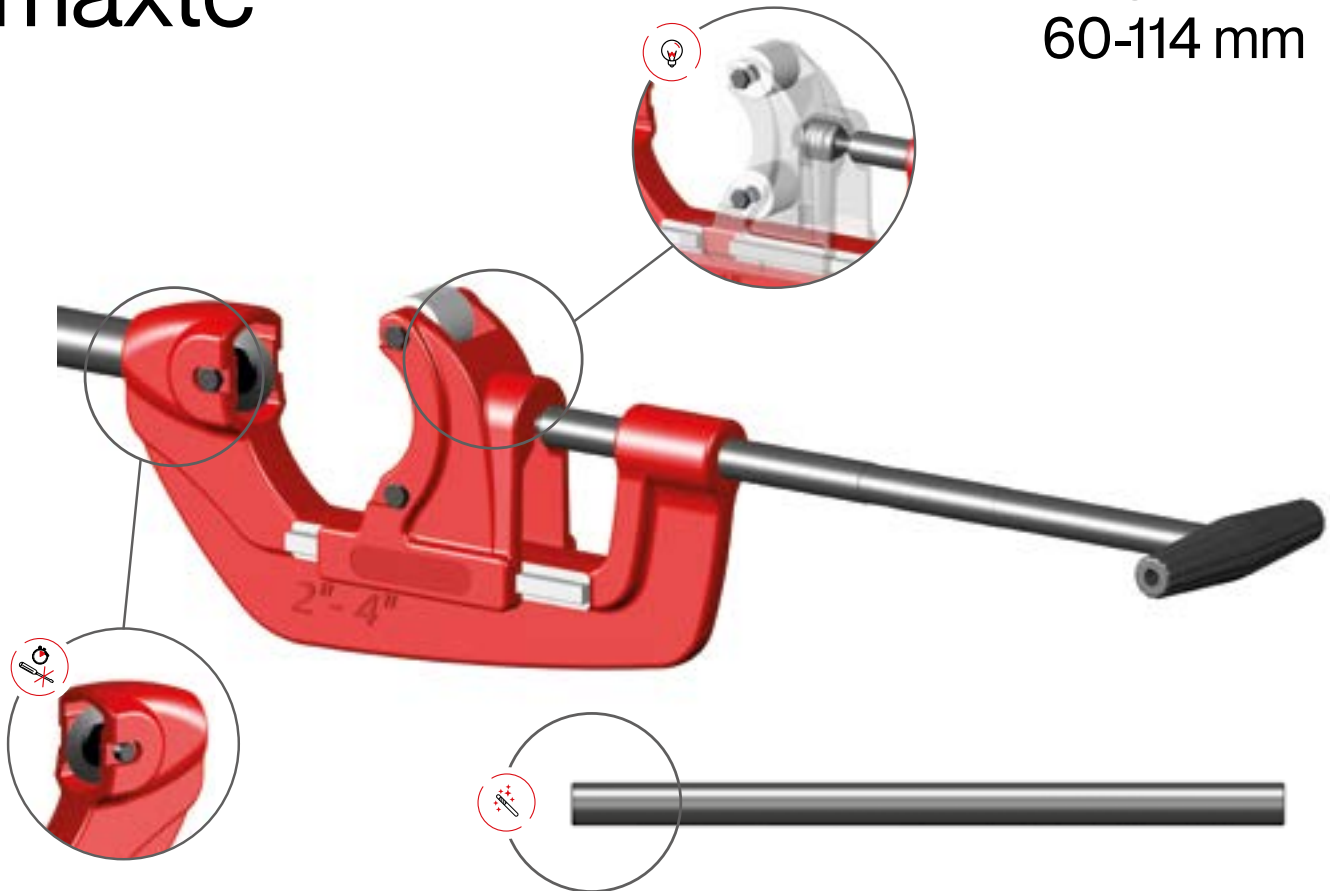

ZENTEN  
Brennspal  
Garten

66

## MERKMALE



### Lösung

Feder-Andrucksystem: Garantiert verbesserten Schnitt und längere Gebrauchsdauer des Schneidrädchens.



### Handlich

Mit Zusatzhilfshebel.



### Sofortiger

ICS-System (Instant Change System).  
Klingen-Schnellwechsel ohne Werkzeug.

## STAHL- UND INOX(MAX. 10,0 mm)

Ref.	Ext. Ø mm			Verpackung		
6054-1	60-114	1x	6615	Bedruckte Schachtel	1	4

## ERSATZTEIL



**6015-0**  
41x28mm

**BG Services**  
BY **ZENTEN**



---

# Ersatzrädchen und Ersatzklingen

Zukunftsorientiert denken —————>

ZENTEN



09.

INDOX  
MADE IN SOILINGEN  
GERMANY

INDEX

# ↘ Ersatzrädchen und Ersatzklingen

Für flexible Kunststoffschläuche

Ref.	Verpackung		Ref.	Verpackung	
5009-1	SB-Beutel	+ PTFE	5011-1	SB-Beutel	+ PTFE

Für flexible Schläuche, weiche Kunststoffrohre und dünnwandige Kunststoffrohre

Ref.	Verpackung	
5007-1	SB-Beutel	+ PTFE



Für Kunststoffwellschutzrohre

Ref.	Verpackung	
5013-1	3 ST. SB-Beutel	



Für PEX

Ref.	Verpackung	
5007-3	SB-Beutel	



Für Verbundrohre



Ref.	Verpackung		Ref.	Verpackung	
5006-1	SB-Beutel	+ PTFE	5008-1	SB-Beutel	+ PTFE 4 ST.



Für Stahl- und Inox Rohre

Ref.		Ø mm	Verpackung	
6014-0	25x14	5,50	Lose	
6014-1	25x14	5,50	SB	

Für Inox Rohre



Ref.		Ø mm	Verpackung	
6001-8	19x5	2	Lose	
6001-9	19x5	2	SB	
6005-8	19x6,2	2	Lose	
6005-9	19x6,2	2	SB	



Ref.		Ø mm	Verpackung	
6002-0	31x19	7	Lose	
6002-1	31x19	7	SB	

Ref.		Ø mm	Verpackung	
6015-0	41x28	10	Lose	
6015-1	41x28	10	SB	



Für dünnwandige Metallrohre

Al, Cu und Inox

Ref.		Ø mm	Verpackung	
6001-0	19x5	2	Lose	
6001-1	19x5	2	SB	
6005-0	19x6,2	2	Lose	
6005-1	19x6,2	2	SB	

Ref.		Ø mm	Verpackung	
7402-0	25x11	6	Lose	
7402-1	25x11	6	SB-Beutel	

AL, CU

Ref.		Ø mm	Verpackung	
6008-0	19x5	2	Lose	
6008-1	19x5	2	SB	
6009-0	19x6,2	2	Lose	
6009-1	19x6,2	2	SB	

Für Kunststoff- und Verbundrohre



Ref.	Verpackung		Ref.	Verpackung	
5005-1	SB-Hülle	+ PTFE	5003-1	SB-Hülle	+ PTFE

Ref.	Verpackung		Ref.	Verpackung	
5001-1	SB-Hülle	+ PTFE	5004-1	SB-Hülle	+ PTFE



Ref.	Verpackung	
5002-1	SB-Hülle	+ PTFE

## ↳ Ersatzrädchen und Ersatzklingen



### Für Kunststoff- und Verbundrohre

Ref.		mm	Verpackung	
6007-0	22x5	4	Lose	
6007-1	22x5	4	SB	
6011-0	22x6,2	4	Lose	
6011-1	22x6,2	4	SB	

Ref.		mm	Verpackung	
6017-0	30x6,2	8,60	Lose	
6017-1	30x6,2	8,60	SB	

Ref.		mm	Verpackung	
7403-0	35x11	11,80	Lose	
7403-1	35x11	11,80	SB-Beutel	+ PTFE

### Für Kunststoff- und Verbundrohre

Ref.		mm	Verpackung	
7404-0	45x11	16,80	Lose	
7404-1	45x11	16,80	SB-Beutel	+ PTFE



  

Ref.		mm	Verpackung	
7405-0	51x11	19,80	Lose	
7405-1	51x11	19,80	SB-Beutel	+ PTFE



  

Ref.		mm	Verpackung	
7406-0	67x11	27,80	Lose	
7406-1	67x11	27,80	SB-Beutel	+ PTFE

### Für dünnwandige Kunststoffrohre

Ref.		mm	Verpackung	
7407-0	45x11	16,80	Lose	
7407-1	45x11	16,80	SB-Beutel	

Ref.		mm	Verpackung	
7409-0	51x11	19,80	Lose	
7409-1	51x11	19,80	SB-Beutel	

# ↘ Ersatzrädchen und Ersatzklingen

REF.	D mm	d mm	W mm	7016 7025 7030 7035 7036 6230	7316 7325 7330 7335 7336 6430	7230 7235 7245	7135 7145	7530 7535 7545	7435 7445	7454 7476	7554 7576	7477 7478	6042	6050	6054	MATERIAL	MAX. ROHR WAND mm
6001-0	19.00	5.00	5.00	•			•									Al, Cu und Inox	2.00
6001-1	19.00	5.00	5.00	•			•									Al, Cu und Inox	2.00
6001-8	19.00	5.00	5.00			•										Speziell für Inox	2.00
6001-9	19.00	5.00	5.00			•										Speziell für Inox	2.00
6005-0	19.00	4.85	6.20		•				•	•						Al, Cu und Inox	2.00
6005-1	19.00	4.85	6.20		•				•	•						Al, Cu und Inox	2.00
6005-8	19.00	4.85	6.20					•			•					Speziell für Inox	2.00
6005-9	19.00	4.85	6.20					•			•					Speziell für Inox	2.00
7402-0	25.00	8.00	11.00									•				Al, Cu und Inox	6.00
7402-1	25.00	8.00	11.00									•				Al, Cu und Inox	6.00
6017-0	30.00	4.85	6.20							•						KST und Verbund.	8.60
6017-1	30.00	4.85	6.20							•						KST und Verbund.	8.60
6007-0	22.00	5.00	5.00				•									KST und Verbund.	4.00
6007-1	22.00	5.00	5.00				•									KST und Verbund.	4.00
6011-0	22.00	4.85	6.20						•							KST und Verbund.	4.00
6011-1	22.00	4.85	6.20						•							KST und Verbund.	4.00
7403-0	35.00	8.00	11.00										•			KST und Verbund.	11.80
7403-1	35.00	8.00	11.00										•			KST und Verbund.	11.80
7404-0	45.00	8.00	11.00										•			KST und Verbund.	16.80
7404-1	45.00	8.00	11.00										•			KST und Verbund.	16.80
7405-0	51.00	4.85	6.20										•			KST und Verbund.	19.80
7405-1	51.00	8.00	11.00										•			KST und Verbund.	19.80
7406-0	67.00	8.00	11.00										•			KST und Verbund.	27.80
7406-1	67.00	8.00	11.00										•			KST und Verbund.	27.80
7407-0	45.00	8.00	11.00										•			Weicher KST	16.80
7407-1	45.00	8.00	11.00										•			Weicher KST	16.80
7409-0	51.00	8.00	11.00										•			Weicher KST	19.80
7409-1	51.00	8.00	11.00										•			Weicher KST	19.80
6008-0	19.00	5.00	5.00	•			•									Al, Cu	2.00
6008-1	19.00	5.00	5.00	•			•									Al, Cu	2.00
6009-0	19.00	4.85	6.20		•				•	•						Al, Cu	2.00
6009-1	19.00	4.85	6.20		•				•	•						Al, Cu	2.00
6014-0	25.00	7.60	14.00										•			Stahl und Inox	5.50
6014-1	25.00	7.60	14.00										•			Stahl und Inox	5.50
6002-0	31.00	9.05	19.00											•		Stahl und Inox	7.00
6002-1	31.00	9.05	19.00											•		Stahl und Inox	7.00
6015-0	41.00	9.70	28.00												•	Stahl und Inox	10.00
6015-1	41.00	9.70	28.00												•	Stahl und Inox	10.00

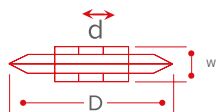

# ↘ Ersatzachsen für Schneidrädchen und Klingen

REF.	7016	7316	7025	7325	7030	7330	7035	7335	7036	7336	6230 7230	6430 7530	7135 7235	7435 7535	7145 7245	7445 7545	7454 7554 7476 7576	7477	7478	6042	6050	6054	5026 5035 5042 5050 5063
6004-0	•		•		•		•		•		•		•		•								
6004-2		•		•		•		•		•		•		•		•	•						
7401-0																		•	•				
6004-7																				•			
6004-8																					•		
6004-9																						•	
5010-0																						•	



---

# Installationswerkzeuge

Zukunftsorientiert denken —————>

ZENTEN

10.

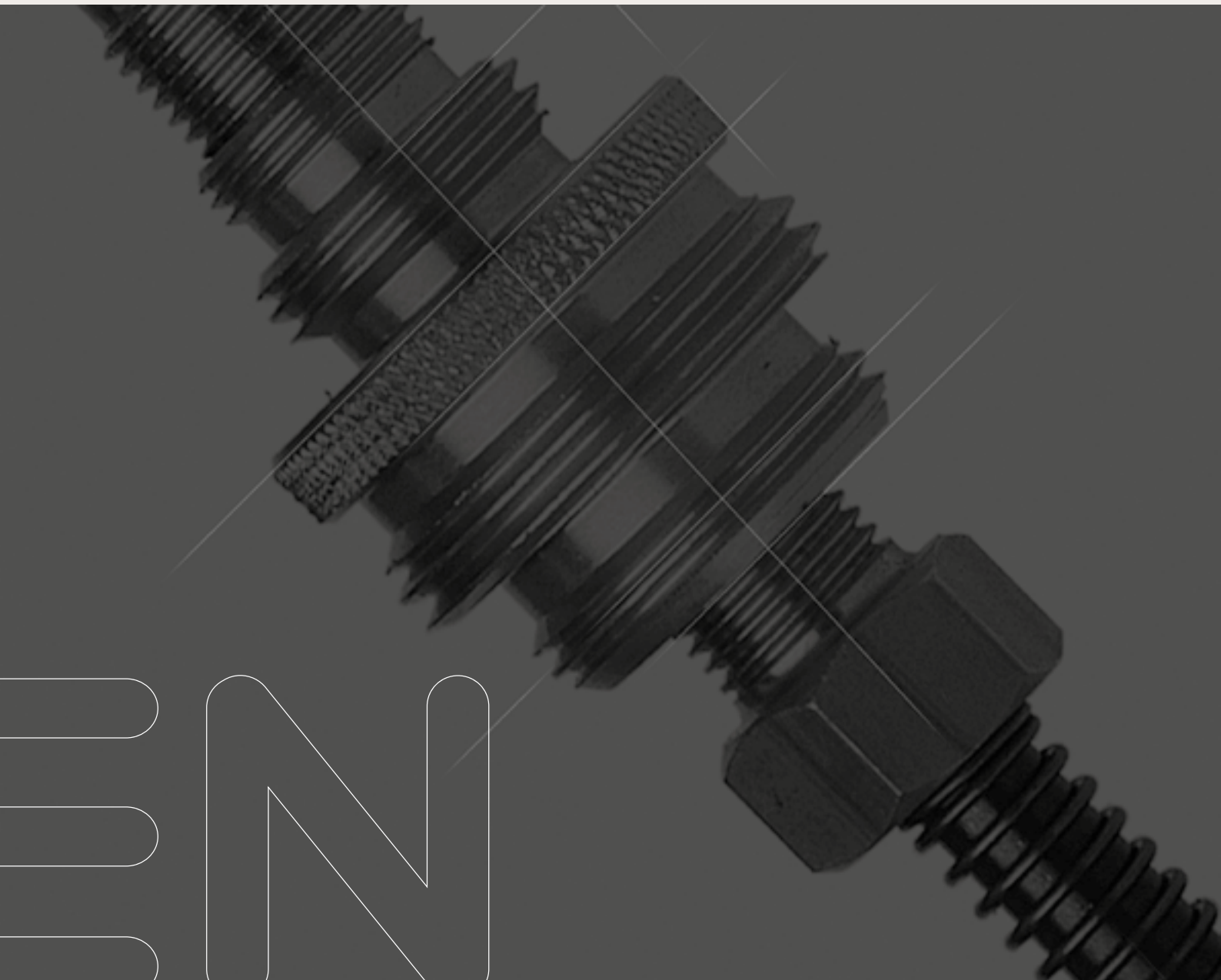

# ↘ Installationswerkzeuge

Wasserhahn-Ventil-Sitzfräser.



**Resistent**

Körper aus Messing und Fräser aus gehärtetem Stahl.



2  $\frac{3}{8}$ " + 1/2"

Ref. Verpackung

6111-1	180	SB	5	50
--------	-----	----	---	----

2x: juntas · Dichtungen · washers · joints



2  $\frac{3}{8}$ " + 1/2"

Ref. Verpackung

6112-1	175	SB	5	50
--------	-----	----	---	----

2x: juntas · Dichtungen · washers · joints



3  $\frac{3}{8}$ " + 1/2" + 3/4"  
 4  $\frac{3}{8}$ " + 1/2" + 3/4" + 1"  
 5  $\frac{1}{4}$ " + 3/8" + 1/2" + 3/4" + 1"  
 4  $\frac{3}{8}$ " + 1/2" + 3/4" + 1"

Ref. Verpackung

6105-2	350	Lose	1	20/40
--------	-----	------	---	-------

6115-2	360	Lose	1	20/40
--------	-----	------	---	-------

6115-3	365	Lose	1	20/40
--------	-----	------	---	-------

● 6115-5	925	Lose	1	-
----------	-----	------	---	---

ZENTEN

76



4  $\frac{3}{8}$ " + 1/2" + 3/4" + 1"

Ref. Verpackung

6116-2	530	Lose	1	20/40
--------	-----	------	---	-------



4  $\frac{3}{8}$ " + 1/2" + 3/4" + 1"

Ref. Verpackung

6118-2	465	Lose	1	20/40
--------	-----	------	---	-------

● In Metallkassette



REF: 6260-0

560 1

Lose Fräser



REF: 6210-0 / 10mm 1/8"  
 REF: 6212-0 / 12mm 1/4"  
 REF: 6214-0 / 14mm 3/8"  
 REF: 6217-0 / 17mm 1/2"

REF: 6220-0 / 20mm 5/8"  
 REF: 6224-0 / 24mm 3/4"  
 REF: 6228-0 / 28mm 1"

Leimzangen



Ref.  $\leftrightarrow$  mm. Verpackung

7100-0	100	45	Lose	300/400
--------	-----	----	------	---------

7150-0	150	130	Lose	100
--------	-----	-----	------	-----



Ref.  $\leftrightarrow$  mm. Verpackung

7101-0	100	48	Lose	300/400
--------	-----	----	------	---------

7151-0	150	133	Lose	100
--------	-----	-----	------	-----

# ▼ Installationswerkzeuge

## Rohrentgrater



### ø Exterior - Interior (3-42 mm)

Ref.		Verpackung		
6100-0	40	Lose	12	72/144
6100-1	55	SB	10	40

**Resistent**  
Körper aus ABS.

**Qualität**  
Klingen aus Solingen / Germany.

### ø Exterior - Interior (8-35 mm)

Ref.		Verpackung		
6101-0	190	Weißer Schachtel	1	72

**Resistent**  
Körper aus Aluminium.

**Qualität**  
Entgrater aus gehärtetem Stahl.

### ø Exterior - Interior (10-56 mm)

Ref.		Verpackung		
6102-0	430	Weißer Schachtel	1	33

**Resistent**  
Körper aus Aluminium.

**Qualität**  
Entgrater aus gehärtetem Stahl.

---

# Schlagschnurroller

Zukunftsorientiert denken —————>

ZENTEN

# 11.





# squid

15 m. | 30 m.



ZENTEN  
Brand of  
Dreier

## MERKMALE



### Lösung

PUSH System: Beim Druck auf die Achse kann die Schnur im Leerlauf ausgezogen werden und die Kurbel dreht nicht.



### Handlich

Im Körper 100% integrierter Lagerplatz für den Haken.



### Stabil

Flache Flanken auf beiden Seiten, damit der Schlagschnurroller waagrecht liegen kann.



### Verankerung

Gehärteter Haken mit gebogenen Zacken: Kann an Kanten angengelt werden.



### Effizient

Große innere Farbpulverkapazität.



### Praktisch

Mit INOX Gürtelclip.



### Qualität

Mit Stahl-Öse am Schnuraustritt.

REF.				Verpackung		
8091-0	15m	No	150	Lose	6	60
8091-1	15m	No	165	SB	-	48
8191-1	15m	+60g	245	SB	-	48

#### ERSATZTEIL



**8058-0**  
15 m.

REF.				Verpackung		
8092-0	30m	No	160	Lose	6	60
8092-1	30m	No	175	SB	-	48
8192-1	30m	+60g	255	SB	-	48

#### ERSATZTEIL



**8059-0**  
30 m.

# fast squid

15 m. | 30 m.



## MERKMALE



### Lösung

PUSH System: Beim Druck auf die Achse kann die Schnur im Leerlauf ausgezogen werden und die Kurbel dreht nicht.



### Handlich

Im Körper 100% integrierter Lagerplatz für den Haken.



### Schnell

Schnelleinzug Übersetzung 5:1



### Verankerung

Gehärteter Haken mit gebogenen Zacken: Kann an Kanten angengelt werden.



### Effizient

Große innere Farbpulverkapazität.



### Praktisch

Mit INOX Gürtelclip.



### Qualität

Line exit protected with steel-ring.

REF.				Verpackung		
8096-0	15m	No	210	Lose	5	50
8096-1	15m	No	225	SB	-	36
8196-1	15m	+60g	305	SB	-	48

#### ERSATZTEIL



**8058-0**  
15 m.

REF.				Verpackung		
8097-0	30m	No	220	Lose	5	50
8097-1	30m	No	235	SB	-	36
8197-1	30m	+60g	315	SB	-	48

#### ERSATZTEIL



**8059-0**  
30 m.

# basick

15 m. | 30 m.



## MERKMALE



### Effizient

Große innere Farbpulverkapazität.



### Verankerung

Gehärteter Haken mit gebogenen Zacken: kann an Kanten angenagelt werden.



### Qualität

Mit Stahl-Öse am Schnuraustritt.

REF.				Verpackung		
8053-0	15m	No	80	Lose	5	50
8053-1	15m	No	100	SB	-	54
8153-1	15m	+60g	180	SB	-	36

### ERSATZTEIL



**8058-0**  
15 m.

REF.				Verpackung		
8092-0	30m	No	90	Lose	5	50
8092-1	30m	No	110	SB	-	54
8192-1	30m	+60g	190	SB	-	36

### ERSATZTEIL



**8059-0**  
30 m.

## ↘ Farbpulver für Schlagschnurroller

---



### FLASCHEN, LOSE

---



g	●	●	○	●	☰	☰
100g.	8064-0	8064-2	8064-4	8064-6	-	100
250g.	8066-0	8066-2	8066-4	8066-6	-	50
500g.	8068-0	8068-2	-	-	-	35
1000g.	8070-0	8070-2	-	-	-	20

### FLASCHEN MIT AUFHÄNGER

---



g	●	●	○	●	☰	☰
100g.	8064-1	8064-3	8064-5	8064-7	6	72
250g.	8066-1	8066-3	8066-5	8066-7	6	60

---

# Messer

Zukunftsorientiert denken →

ZENTEN

12.

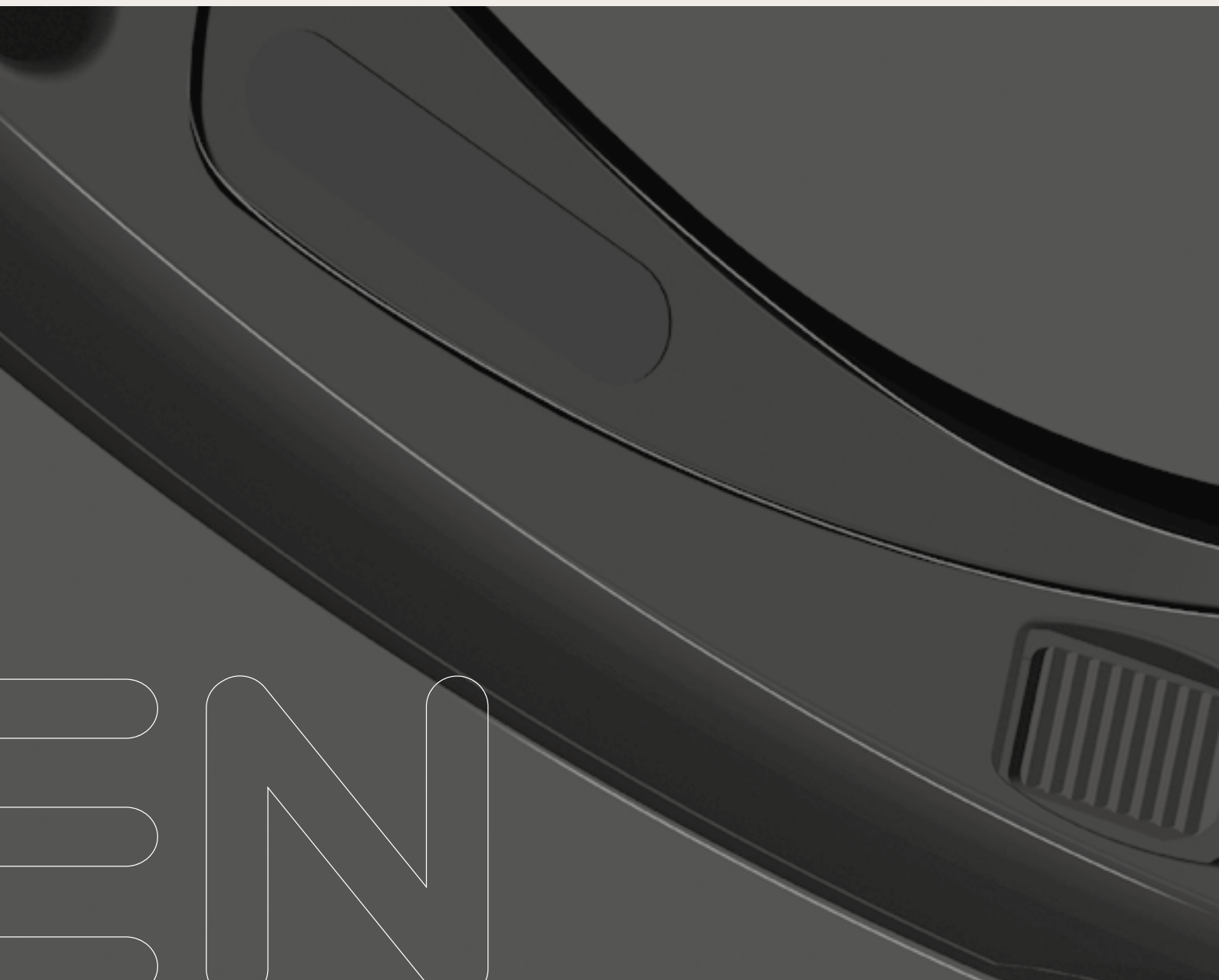



# biko

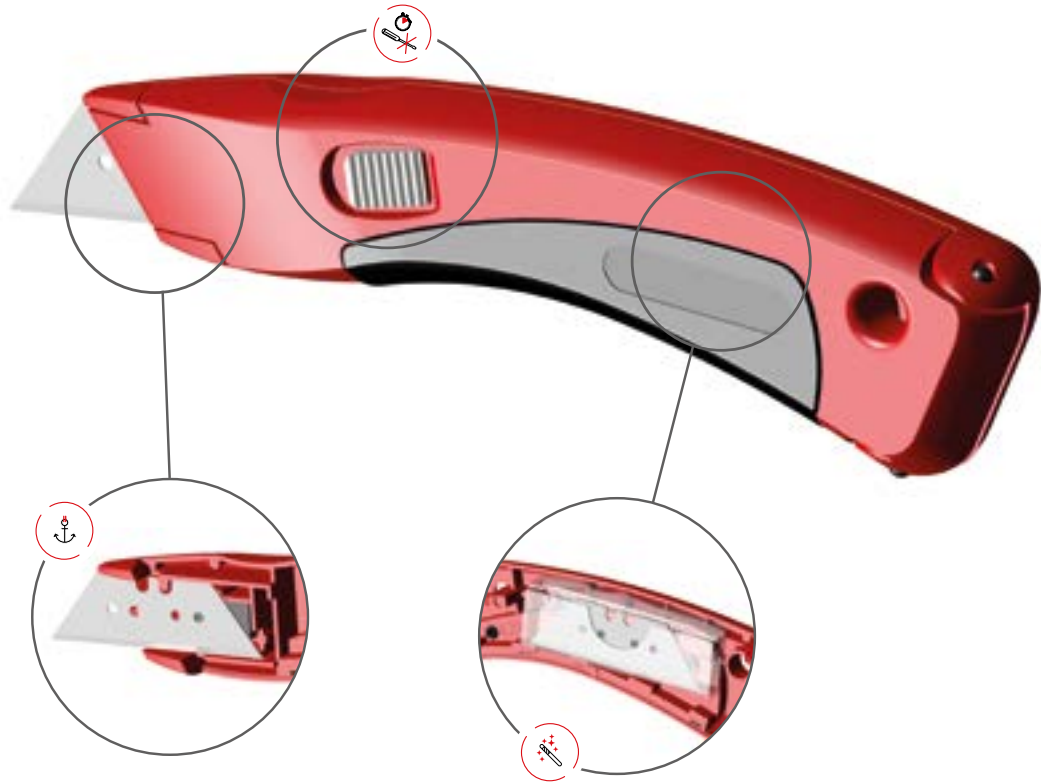

## MERKMALE



### Sofortiger

Klingen-Schnellwechsel ohne Werkzeug.



### Handlich

Klingendepot.



### Verankerung

Klingenthalerung mit Magnet.



### Komfort

Ergonomisches Design mit Kautschuckeinlagen.



Ref.			Verpackung		
8971-2	1x	240	Lose	10	100
8971-3	1x	265	SB	6	72
8981-2	1x	280	Lose	10	50
8981-3	1x	305	SB	-	25

## ERSATZTEIL



**8002-0**  
(60x19x0,65)

# biko

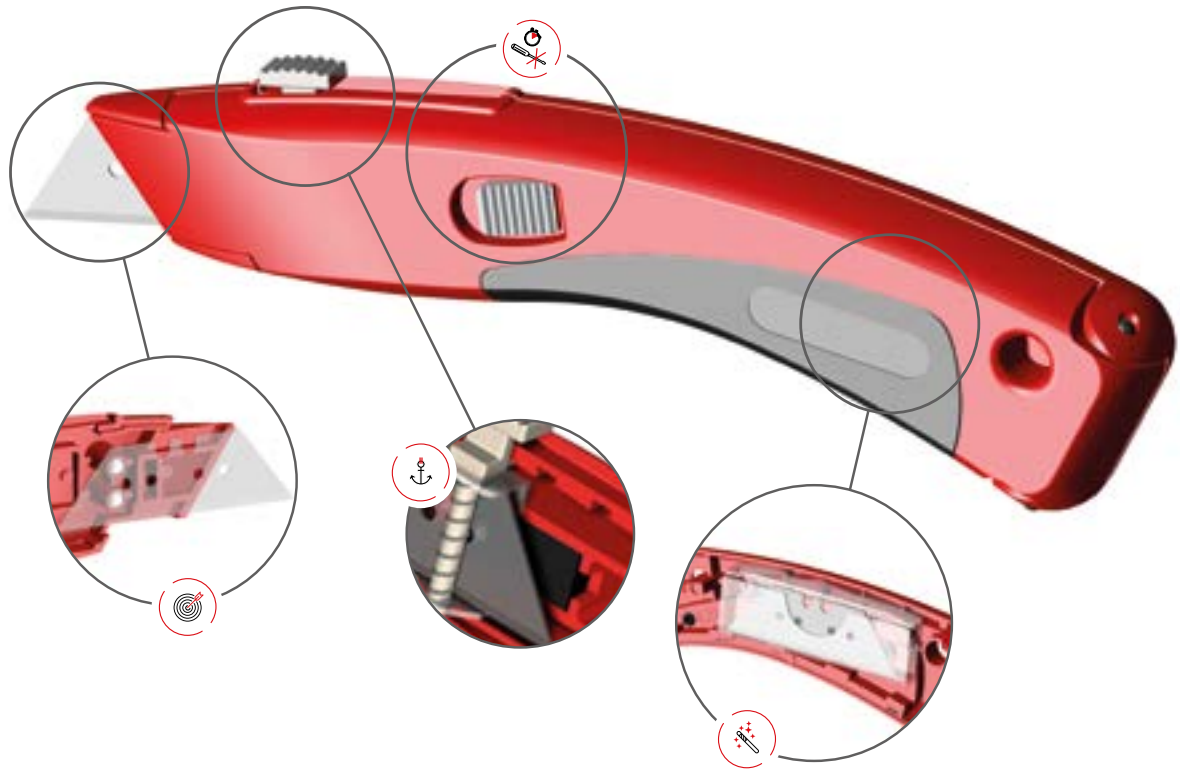

## MERKMALE



### Sofortiger

Klingen-Schnellwechsel ohne Werkzeug.



### Handlich

Klingendepot.



### Verankerung

Klingenhalterung mit Magnet.



### Komfort

Ergonomisches Design mit Kautschuckeinlagen.



### Effizient

Kugel-Federsystem zur Fixierung der Klinge.



Ref.			Verpackung		
8952-2	2x	295	Lose	8	80
8952-3	2x	320	SB	5	50
8962-2	2x	335	Lose	5	50
8962-3	2x	360	SB	-	25

## ERSATZTEIL



**8002-0**  
(60x19x0,65)

biko

9 mm.



MERKMALE



**Handlich**

Mit 2 Ersatzklingen im Klingendepot.



**Praktisch**

Mit Klinsenabbrecher.



**Sicherheit**

Blockiersystem des Schiebers.



**Schutz**

Mit Schutzkappe.

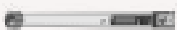

ERSATZTEIL

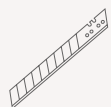

**8007-0 (9 mm)**

Ref.			Verpackung		
8703-0	3x	30	Lose	100	400
8703-1	3x	45	SB	30	120



ERSATZTEIL

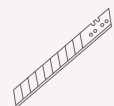

**8007-0 (9 mm)**

Ref.			Verpackung		
8703-2	3x	60	Lose	60	240
8703-3	3x	70	SB	30	120

biko

18 mm. | 22 mm.



MERKMALE



**Handlich**  
Mit 2 Ersatzklingen im Klingendepot.



**Sicherheit**  
Blockiersystem des Schiebers.



**Lösung**  
Automatische Klingennachladung.



**Komfort**  
Ergonomisches Design mit Kautschuckeinlagen.

Ref.			Verpackung		
8713-0	3x	220	Lose	12	120
8713-1	3x	230	SB	6	60

ERSATZTEIL

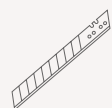

**8008-0** (18 mm)

Ref.			Verpackung		
8723-0	3x	245	Lose	12	120
8723-1	3x	255	SB	6	60

ERSATZTEIL

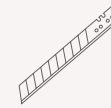

**8009-0** (22 mm)

# eos

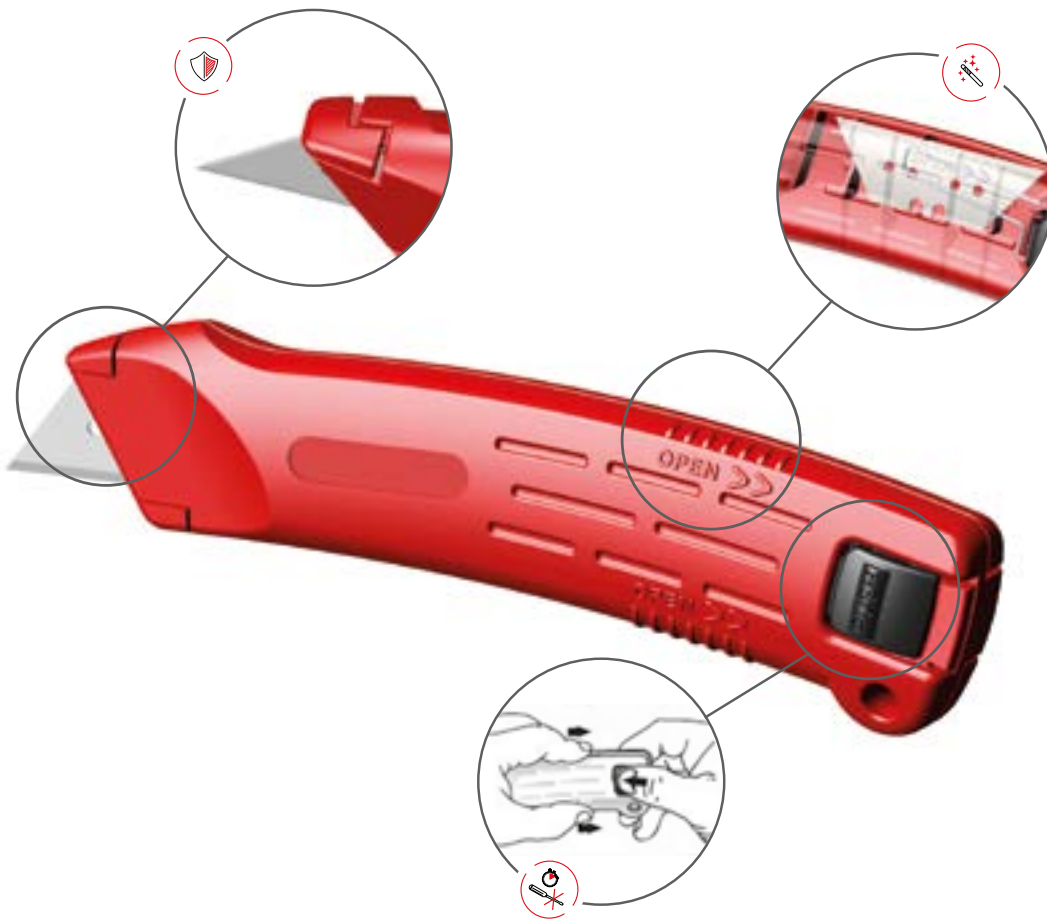

## MERKMALE



**Sofortiger**  
Klingen-Schnellwechsel ohne Werkzeug.



**Handlich**  
Klingendepot.



**Schutz**  
Interlock system.



**Komfort**  
Ergonomisches Design.



Ref.			Verpackung		
8731-2	1x	180	Lose	24	96
8731-3	1x	195	SB	10	120

## ERSATZTEIL



**8002-0**  
(60x19x0,65)

# eos

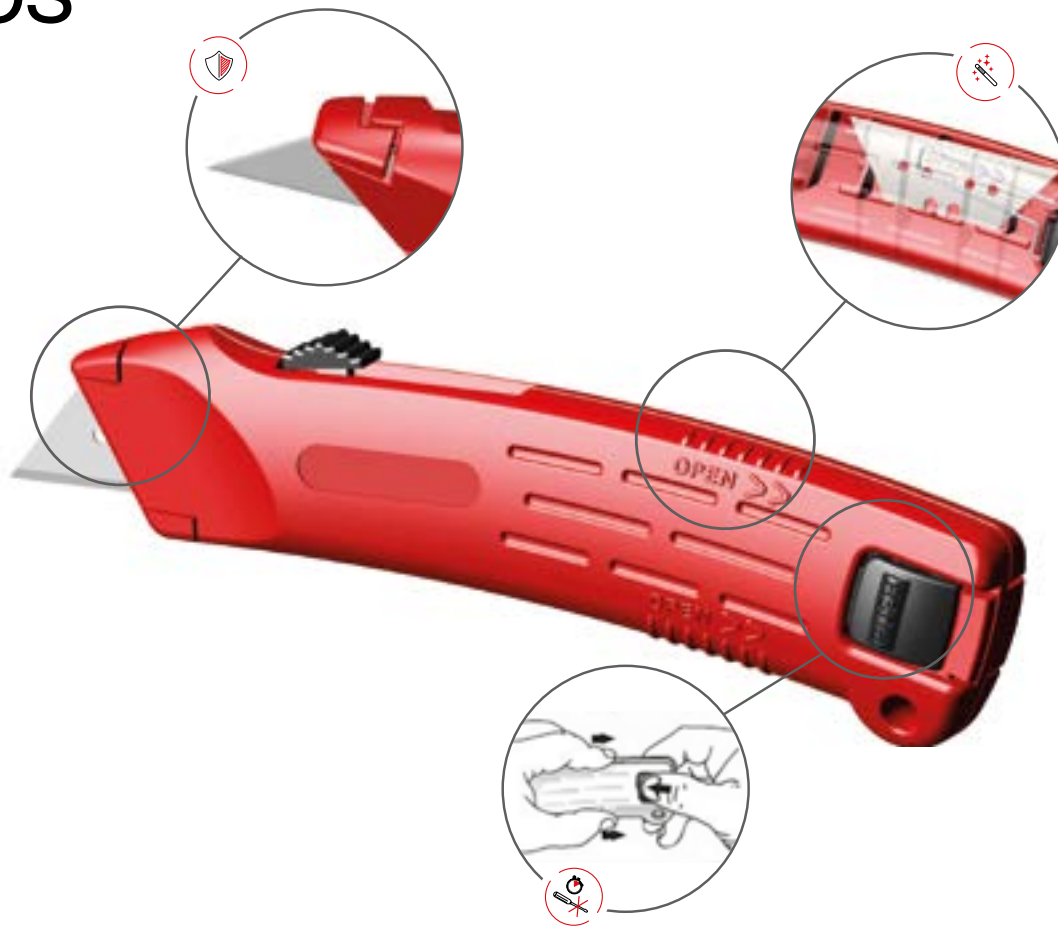

## MERKMALE



### Sofortiger

Klingen-Schnellwechsel ohne Werkzeug.



### Praktisch

Leichter Vorschub des Schiebers.



### Schutz

Interlock system.



### Handlich

Klingendepot.



### Komfort

Ergonomisches Design.

Ref.			Verpackung		
8741-2	1x	185	Lose	24	96
8741-3	1x	200	SB	10	120

## ERSATZTEIL



**8002-0**  
(60x19x0,65)



eos



MERKMALE



**Sofortiger**  
Klingen-Schnellwechsel ohne Werkzeug.



**Sicherheit**  
Mit automatischem Rückzug der Klinge.



**Schutz**  
Interlock system.



**Handlich**  
Klingendepot.



**Komfort**  
Ergonomisches Design.

Ref.			Verpackung		
8751-2	1x	185	Lose	24	96
8751-3	1x	200	SB	10	120

ERSATZTEIL

**8002-0**  
(60x19x0,65)

eos

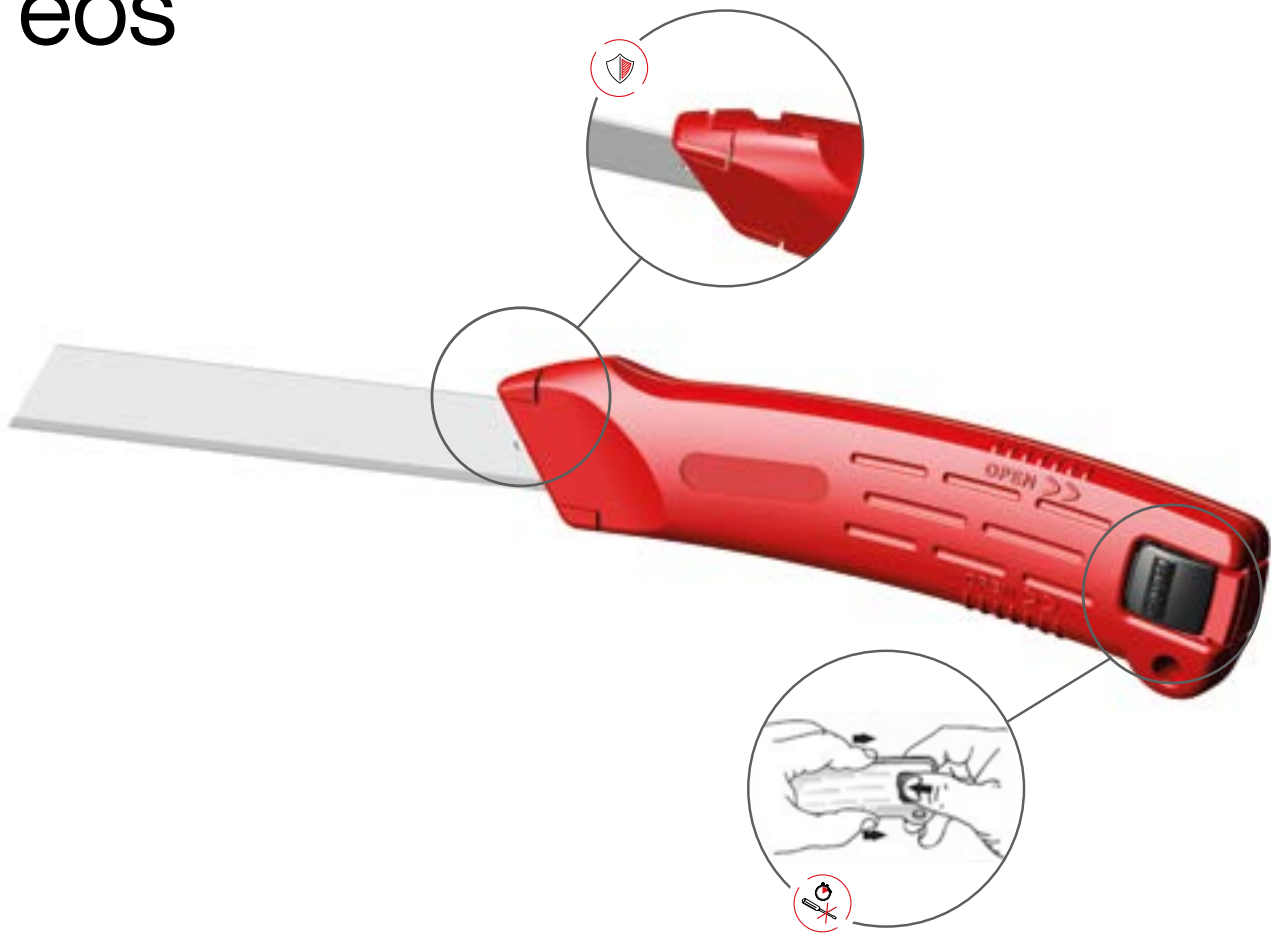

MERKMALE



**Sofortiger**  
Klingen-Schnellwechsel ohne Werkzeug.



**Komfort**  
Ergonomisches Design.



**Schutz**  
Interlock system.

Ref.			Verpackung		
8780-0	1x	205	Lose	12	48
8780-1	1x	235	SB	6	24

ERSATZTEIL

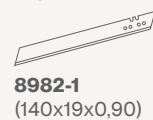

uniko

18 mm.



MERKMALE



**Lösung**

Automatische Klingennachladung.



**Handlich**

Mit 2 Ersatzklingen im Klingendepot.



**Sicherheit**

Blockiersystem des Schiebers.



**Komfort**

Ergonomisches Design.



Ref.			Verpackung		
8763-0	3x	100	Lose	12	120
8763-1	3x	110	SB	6	60

ERSATZTEIL



**8008-0**  
(18 mm)

### Universalmesser

ERSATZTEIL

**8002-0**  
(60x19x0,65)



Ref.			Verpackung		
8031-2	1x	125	Lose	30	120
8031-3	1x	140	SB	10	100



**Komfort**  
Ergonomisches Design.

MODELL: 8031



**8002-0**  
(60x19x0,65)



Ref.			Verpackung		
8121-2	1x	140	Lose	30	120



**Komfort**  
Ergonomisches Design.

MODELL: 8121



### Für Dämmstoff

ERSATZTEIL

**8982-1**  
(140x19x0,90)



Ref.			Verpackung		
8980-0	1x	205	Lose	12	48
8980-1	1x	235	SB	12	48



**Komfort**  
Ergonomisches Design.

MODELL: 8980



### Sicherheitsmesser

ERSATZTEIL

**8002-0**  
(60x19x0,65)



Ref.			Verpackung		
8041-2	1x	155	Lose	30	120
8041-3	1x	170	SB	10	100



**Komfort**  
Ergonomisches Design.

MODELL: 8041



**Praktisch**  
Leichter Vorschub  
des Schiebers dank  
Federsystem.



### Automatikmesser

ERSATZTEIL

**8002-0**  
(60x19x0,65)



Ref.			Verpackung		
8141-2	1x	170	Lose	30	120
8141-3	1x	185	SB	10	120



**Komfort**  
Ergonomisches  
Design.

MODELL: 8141



**Schutz**  
Mit automatischem  
Rückzug der Klinge.



### ERSATZKLINGEN FÜR MESSER



	REF.	Pcs.		8731	8031	8121	8741	8041	8751	8141	8971	8981	8952	8962	8780	8980	8703	8713	8723	8763
60x19x0,65	8002-0	5	100	•	•	•	•	•	•	•	•	•	•	•						
	8012-0	10	100	•	•	•	•	•	•	•	•	•	•	•						
	8012-1	10	50	•	•	•	•	•	•	•	•	•	•	•						
52x19x0,5	8005-0	5	100	•	•	•	•	•	•	•	•	•	•	•						
	8015-0	10	100	•	•	•	•	•	•	•	•	•	•	•						
	8015-1	10	50	•	•	•	•	•	•	•	•	•	•	•						
140x19x0,9	8982-1	2	50			•								•	•					
9 mm 18 mm 22 mm	8007-0	10	100															•		
	8008-0	10	100																•	•
	8009-0	10	100																•	

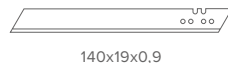



ZENTEN Bernhard  
Groten

Zenten Bernhard Groten S.L.  
Pol. Soroxarta - C/Burniola, 20C  
20305 Irun-Gipuzkoa, SPAIN  
T.: +34 943 613 012

[www.zentenbg.com](http://www.zentenbg.com)



V.1 / DE